



DATASHEET APULN Specification V1.46

Ultra-Low Noise Microwave Signal Generators

8 kHz to 12.75, 20, 26 and 40 GHz



CONTENTS

Definitions	3
Introduction	3
Ultra-Low Noise Microwave Signal Generator 8 kHz to 12.75, 20, 26 and 40 GHz.....	3
Facts & figures & specifications	4
Frequency Parameters / Range.....	4
Phase Noise	4
Spectral Purity	6
Level Performance.....	6
Reverse power protection and output impedance.....	9
Power Level Uncertainty	9
Modulation Capabilities (Option MOD)	11
Chirped Pulse Modulation (Options MOD and FS / NEC).....	13
Amplitude Modulation	13
Frequency Modulation	13
Phase Modulation	13
Sweeping Capability	14
Frequency Reference	14
Trigger	15
Multi-Purpose Output (FUNC OUT): Output is TRIG OUT at rear panel.....	15
GUI	16
Connectors, KEYS	17
Front panel:	17
Rear panel:	17
Ordering Information	18
General Characteristics	19
Document History	20
Notes	21

DEFINITIONS

- The specifications in the following pages describe the warranted performance of the instrument for 23 ± 5 °C after a 30-minute warm-up period.

Typical: Expected mean values, not warranted performance

Min and max: Parameter range that is guaranteed by product design, and/or production tested. Warranted performance specifications include guard-bands to account for the expected statistical performance distribution, measurement uncertainties, and changes in performance due to environmental conditions.

INTRODUCTION

• Ultra-Low Noise Microwave Signal Generator 8 kHz to 12.75, 20, 26 and 40 GHz

The APULN is an ultra-low-noise and fast-switching microwave signal generator covering a continuous frequency range from 100 kHz (8 kHz with option) up to 12.75, 20 GHz, 26 or 40 GHz, respectively, with a lower than 0.001 Hz resolution.

The APULN provides an accurately levelled output power range and high spurious suppression. Advanced frequency synthesis combines the fastest switching speed with ultra-low SSB phase noise and fine frequency and power resolution.

The APULN supports analog AM, FM, PM modulation, as well as frequency chirps and pulse modulation with programmable patterns and narrow pulses.

The APULN allows for fast digital sweeps including flexible list sweeps, where frequency, power and dwell times can be set individually. A flexible triggering system simplifies synchronization within test environments.

All APULN models operate with ultra-stable temperature compensated frequency reference (OCXO) to ensure minimal drift and can be phase-locked to an external reference.

The compact unit allows for full front panel control via touch panel display. It can also be intuitively controlled by a PC based GUI Software. Moreover, the instrument offers various communication interfaces like USB, LAN or GPIB. Each interface allows for easy and fast communication using SCPI 1999 command set. Remote control of the instrument can be quickly attained from any host system. A customer-supplied application programming interface (API) or programming examples for Matlab, Labview, C++ and other commercially available tools make the control implementation very straightforward.

FACTS & FIGURES & SPECIFICATIONS

Frequency Parameters / Range

PARAMETER	MIN	TYPICAL	MAX	NOTE
Frequency Range	100 kHz		12.75 GHz	APULN12
	100 kHz		20 GHz	APULN20
	100 kHz		26 GHz	APULN26
	100 kHz		40 GHz	APULN40
	8 kHz		Fmax	Option 8K
Resolution		0.001 Hz		
Phase Resolution		0.01 deg		
Switching Speed SCPI CW mode Sweep / List Mode		1.5 ms 500 μ s 30 μ s See sweep		Valid signal after SCPI received. Option FS Option NEC

Phase Noise

PARAMETER	MIN	TYPICAL	MAX	NOTE
SSB Phase noise at 1 GHz				(See also plots / tables)
at 10 Hz from carrier		-87 dBc/Hz -100 dBc/Hz	-86 dBc/Hz	Option LN
at 1 kHz from carrier		-130 dBc/Hz	-125 dBc/Hz	
at 100 kHz from carrier		-148 dBc/Hz	-144 dBc/Hz	
SSB Phase noise at 4 GHz				
at 10 Hz from carrier		-74 dBc/Hz -86 dBc/Hz	-68 dBc/Hz -74 dBc/Hz	Option LN
at 1 kHz from carrier		-118 dBc/Hz	-114 dBc/Hz	
at 100 kHz from carrier		-136 dBc/Hz	-132 dBc/Hz	
SSB Phase noise at 10 GHz				
at 10 Hz from carrier		-67 dBc/Hz -78 dBc/Hz	-60 dBc/Hz -66 dBc/Hz	Option LN
at 1 kHz from carrier		-108 dBc/Hz	-104 dBc/Hz	
at 100 kHz from carrier		-127 dBc/Hz	-123 dBc/Hz	
SSB Phase noise at 40 GHz				
at 10 Hz from carrier		-55 dBc/Hz -66 dBc/Hz	-48 dBc/Hz -53 dBc/Hz	Option LN
at 1 kHz from carrier		-96 dBc/Hz	-92 dBc/Hz	
at 100 kHz from carrier		-115 dBc/Hz	-111 dBc/Hz	

Figure 1: SSB Phase Noise Performance with option LN

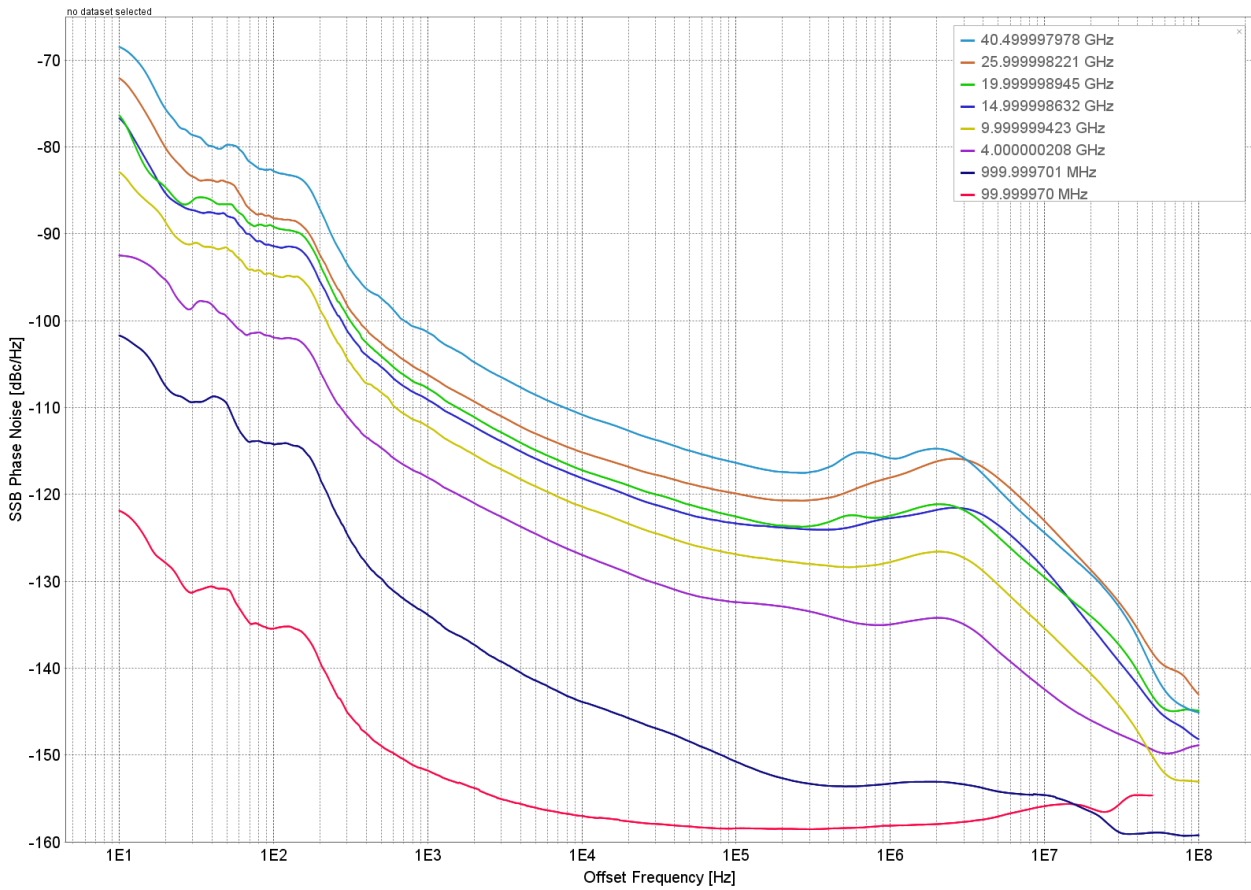
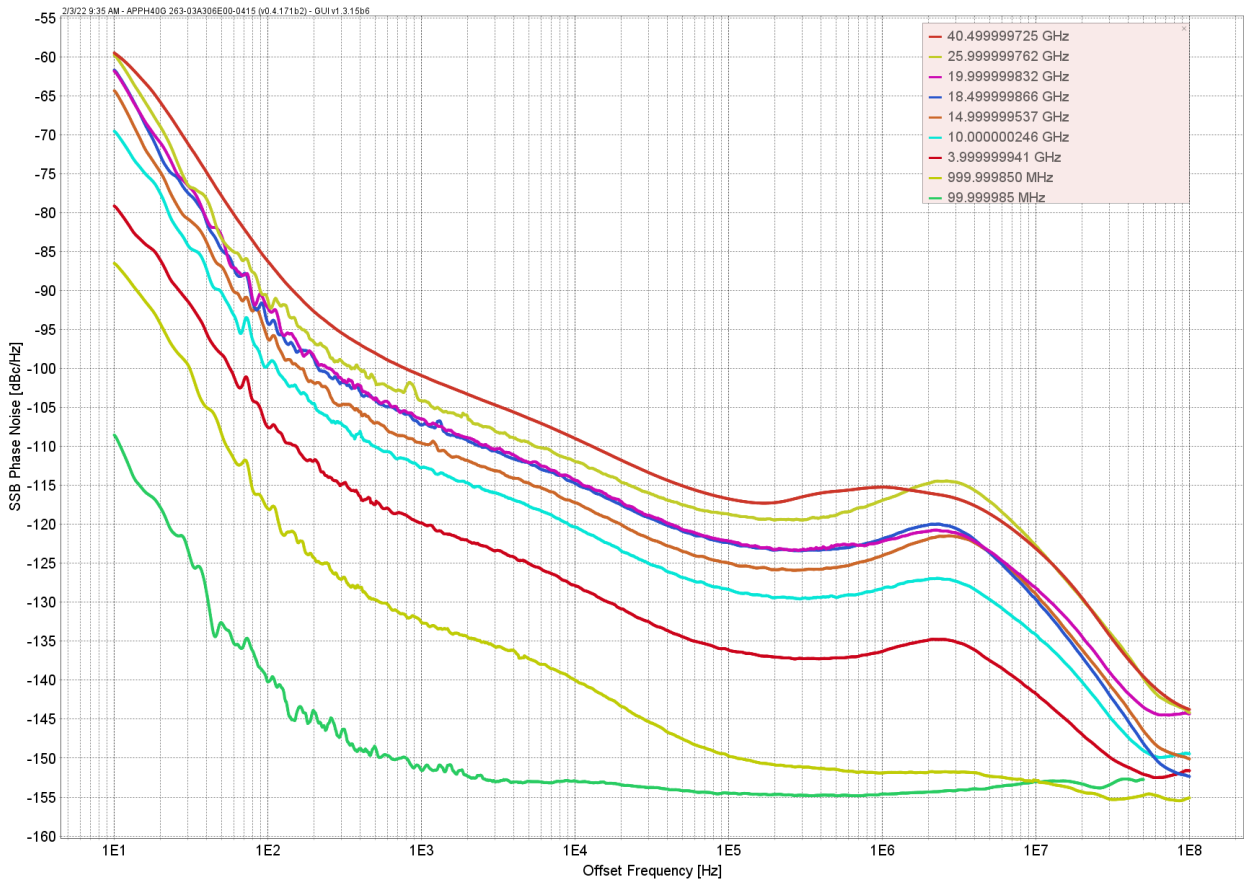

Figure 2: SSB Phase Noise Performance, without option LN





Spectral Purity

PARAMETER	MIN	TYPICAL	MAX	NOTE
Harmonics (at 0 dBm Pout)				
0.01 to 6 GHz		-40 dBc	-30 dBc	APULN12/20 APULN26/40 all models, See plots
>6 GHz		-35 dBc	-30 dBc	
>10.5 GHz		-55 dBc	-45 dBc	
Option FILT, >1 GHz		-30 dBc	-25 dBc	
		-60 dBc	-48 dBc	
Sub-Harmonics (at 0 dBm)				
<5 GHz		-75 dBc	-65 dBc	
5 - 20 GHz		-70 dBc	-60 dBc	
>20 GHz		-55 dBc	-50 dBc	
Option FILT, >20 GHz		-65 dBc	-55 dBc	
Non-Harmonic Spurious (at +0 dBm)				> 10 kHz offset
<1.2 GHz		-90 dBc	-60 dBc	
1.2 - 2.5 GHz		-92 dBc	-60 dBc	
2.5 - 5 GHz		-90 dBc	-58 dBc	
5 - 10 GHz		-84 dBc	-58 dBc	
10 - 20 GHz		-80 dBc	-58 dBc	
>20 GHz		-70 dBc	-50 dBc	

Figure 3: Harmonics (2nd, 3rd at P=+5 dBm, APULN40 with option FILT)

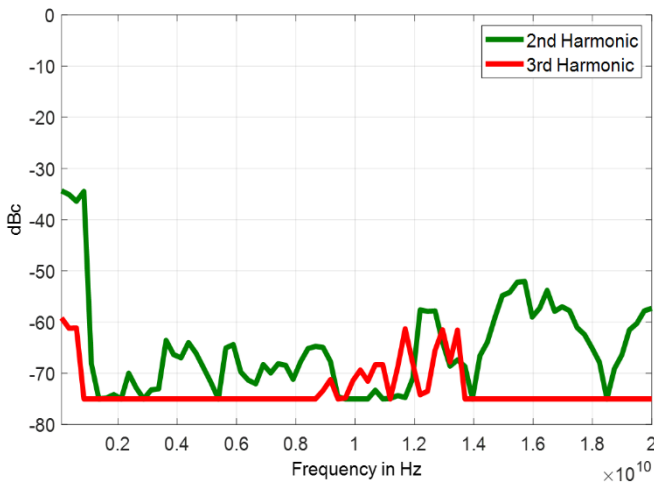
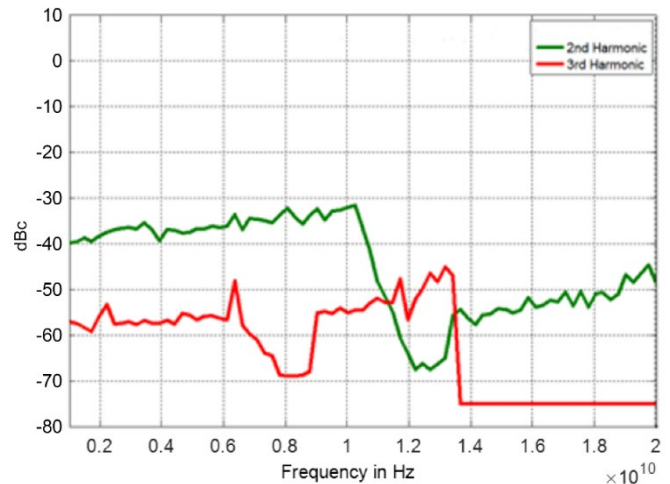

Figure 4: Harmonics (2nd, 3rd at P=5 dBm, APULN20)



Level Performance

PARAMETER	MIN	TYPICAL	MAX	NOTE
Output Power Range (APULN12&20)				
8 to 100 kHz	-25 dBm		+15 dBm	Option 8K
0.1 to 10 MHz	-25 dBm		+24 dBm	
0.01 to 5 GHz	-25 dBm		+26 dBm	
5 to 12.75 GHz	-25 dBm		+24 dBm	
12.75 to 18 GHz	-25 dBm		+22 dBm	
18 to 20 GHz	-25 dBm		+20 dBm	
Output Power Range (APULN12&20 with mechanical step attenuator, option PE)				
0.1 to 10 MHz	-90 dBm		+23 dBm	
0.01 to 5 GHz	-90 dBm		+25 dBm	
5 to 12.75 GHz	-90 dBm		+23 dBm	
12.75 to 18 GHz	-90 dBm		+19 dBm	
18 to 20 GHz	-90 dBm		+17 dBm	
Output Power Range (APULN12&20 with mechanical step attenuator, option PE2)				
0.1 to 10 MHz	-120 dBm		+23 dBm	
0.01 to 6 GHz	-120 dBm		+24 dBm	
6 to 12.75 GHz	-120 dBm		+21 dBm	

12.75 to 20 GHz	-120 dBm		+19 dBm	
18 to 20 GHz	-120 dBm		+17 dBm	
Output Power Range (APULN40)				
8 to 100 kHz	-25 dBm		+15 dBm	Option 8K
0.1 to 10 MHz	-25 dBm		+24 dBm	
0.01 to 6 GHz	-25 dBm		+25 dBm	
6 to 12.75 GHz	-25 dBm		+24 dBm	
12.75 to 26 GHz	-25 dBm		+21 dBm	
26 to 40 GHz	-25 dBm		+18 dBm	See plot
Output Power Range (APULN40 with electrical step attenuator, option PE4)				
0.1 to 10 MHz	-55 dBm		+23 dBm	
0.01 to 6 GHz	-55 dBm		+24 dBm	
6 to 12.75 GHz	-55 dBm		+22 dBm	
12.75 to 20 GHz	-55 dBm		+20 dBm	
20 to 30 GHz	-55 dBm		+17 dBm	
30 to 40 GHz	-55 dBm		+14 dBm	See plot
Output Power Range (APULN40 with mechanical step attenuator, option PE)				
0.1 to 10 MHz	-90 dBm		+24 dBm	
0.01 to 6 GHz	-90 dBm		+24 dBm	
6 to 12.75 GHz	-90 dBm		+22 dBm	
12.75 to 20 GHz	-90 dBm		+21 dBm	
20 to 30 GHz	-90 dBm		+18 dBm	
30 to 35 GHz	-90 dBm		+17 dBm	
35 to 40 GHz	-90 dBm		+16 dBm	
Output Power Range (APULN40 with mechanical step attenuator, option PE2)				
0.1 to 10 MHz	-120 dBm		+23 dBm	
0.01 to 6 GHz	-120 dBm		+24 dBm	
6 to 12.75 GHz	-120 dBm		+22 dBm	
12.75 to 20 GHz	-120 dBm		+21 dBm	
20 to 30 GHz	-120 dBm		+17 dBm	
30 to 35 GHz	-120 dBm		+16 dBm	
35 to 40 GHz	-120 dBm		+15 dBm	See plot
Output Power Range (all APULN with option FILT)				
0.1 to 10 MHz	-25 dBm		+15 dBm	
0.01 to 20 GHz	-25 dBm		+13 dBm	
20 to 40 GHz	-25 dBm		+10 dBm	See plot
Output Power Range (all APULN with option FILT, PE/PE2)				
0.1 to 10 MHz	-120 dBm		+15 dBm	
0.01 to 20 GHz	-120 dBm		+13 dBm	
20 to 35 GHz	-120 dBm		+10 dBm	
35 to 40 GHz	-120 dBm		+6 dBm	See plot
Power Resolution		0.01 dB		

Figure 5: Maximum Output Power 0.01 to 40 GHz

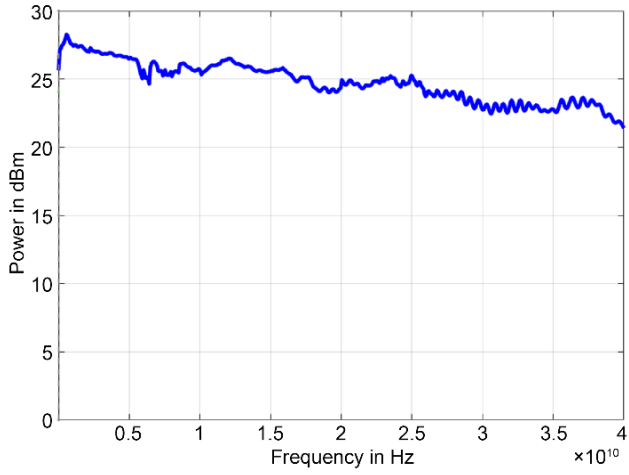

Figure 6: Max Output Power 0.01 to 40 GHz (APULN40 with option PE4)

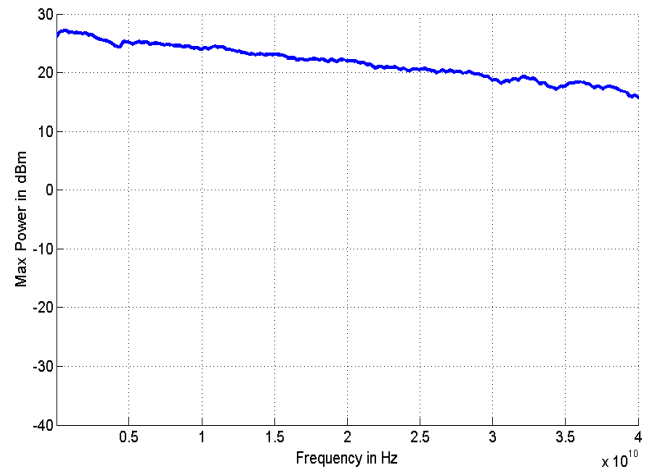

Figure 7: Max Output Power 0.01 to 40 GHz (with option FILT+PE2)

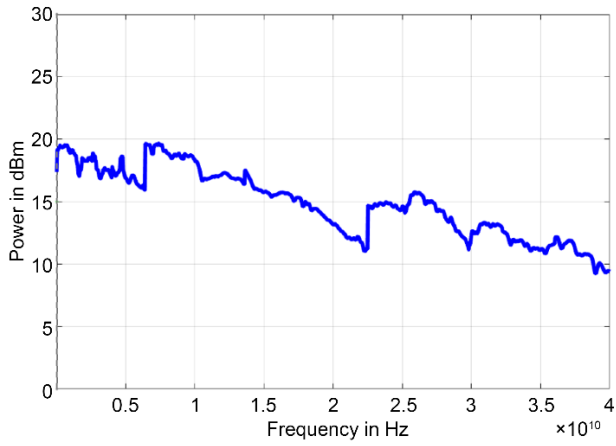

Figure 8: Max Output Power 0.01 to 40 GHz (with option PE/PE2)

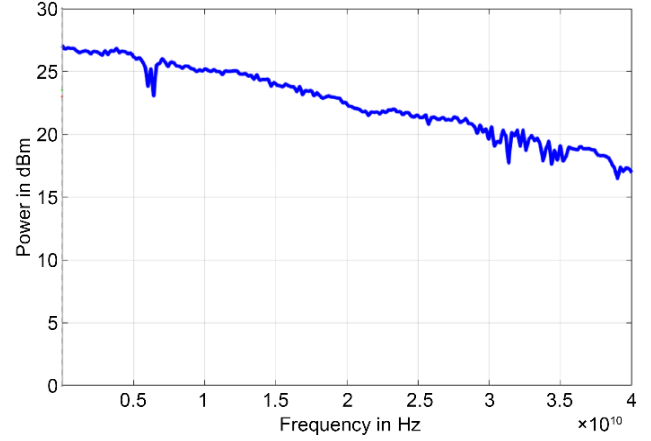
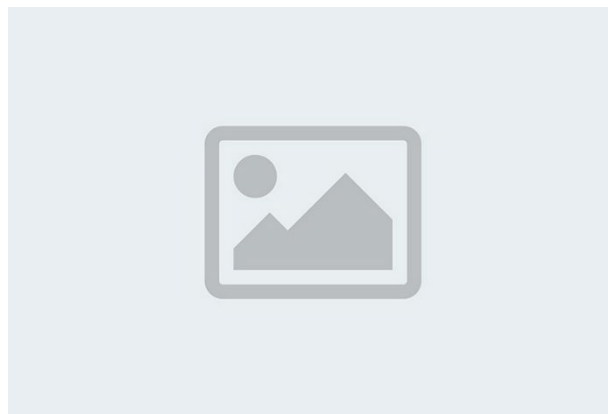

Figure 9: Max Output Power 8 kHz to 100 kHz (with option 8K)
tba



Reverse power protection and output impedance

PARAMETER	MIN	TYPICAL	MAX	NOTE
Reverse Power Protection				
DC Voltage			±10 V	
RF Power			30 dBm	
Output impedance		50 Ohms		
VSWR		1.4	1.9	

Figure 10: Typical VSWR (APULN20)

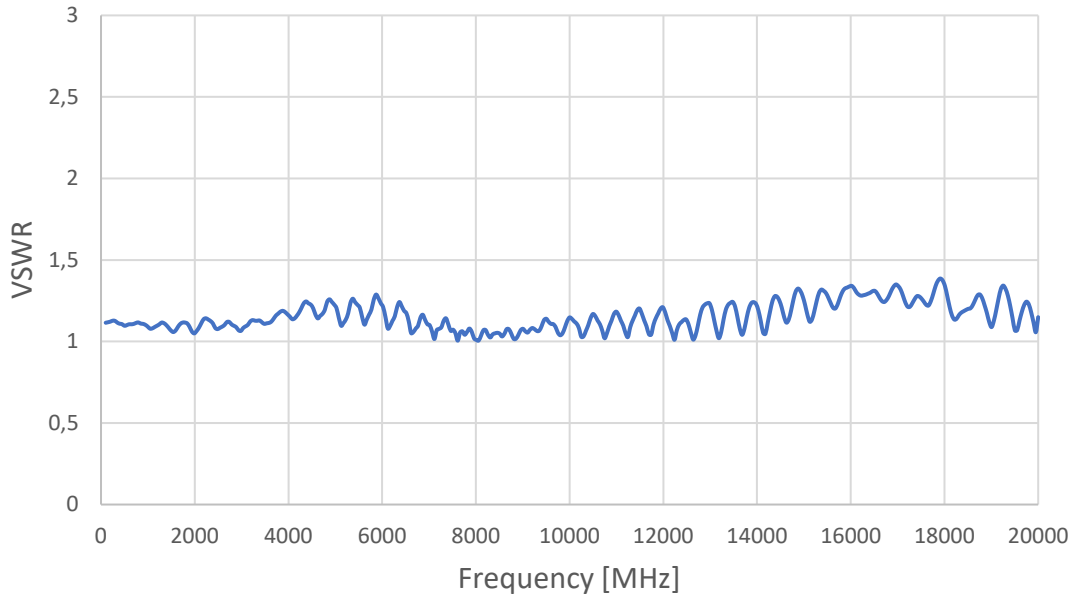

Power Level Uncertainty

(): Typical value

	Max power to -15 to +15 dBm	-70 to -15 dBm, option PE/PE2	-110 to -70 dBm, option PE/PE2
< 6 GHz	0.8 dB (0.25 dB)	1.1 dB	2.0 dB
6 to 12.75 GHz	0.9 dB (0.3 dB)	1.2 dB	2.0 dB
12.75 to 26 GHz	1.0 dB (0.3 dB)	1.4 dB	2.0 dB
26 to 40 GHz	1.2 dB (0.4 dB)	1.5 dB	2.1 dB

Figure 11: Typical Frequency Response 0 to 20 GHz at different power levels (APULN20)

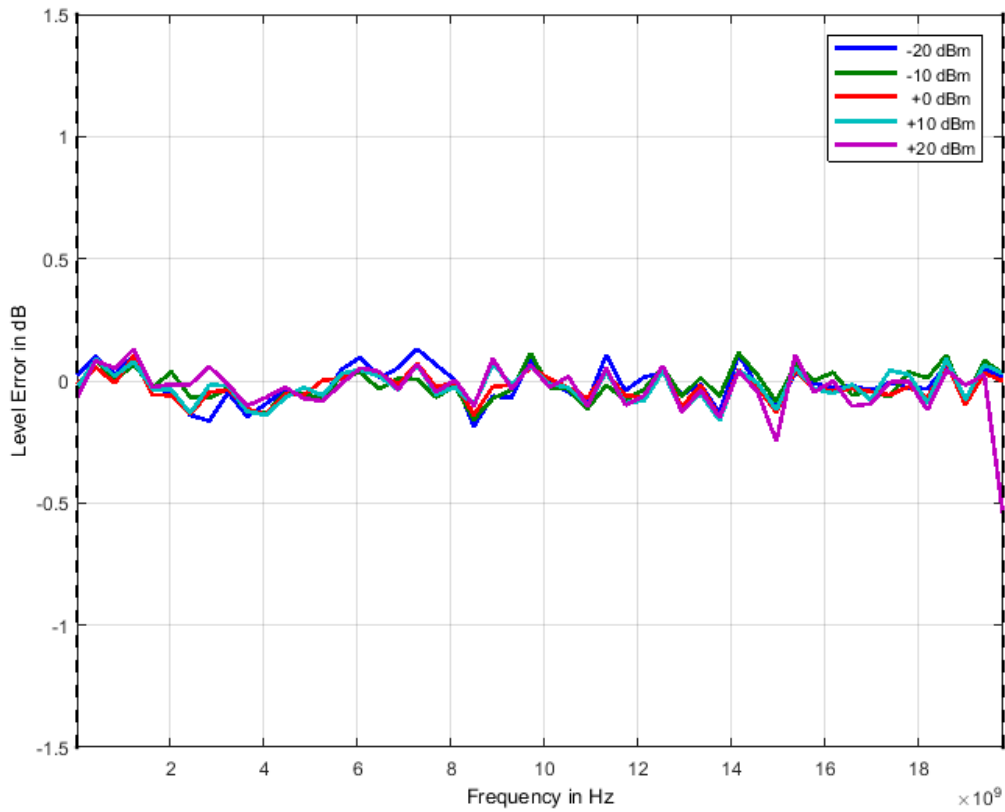
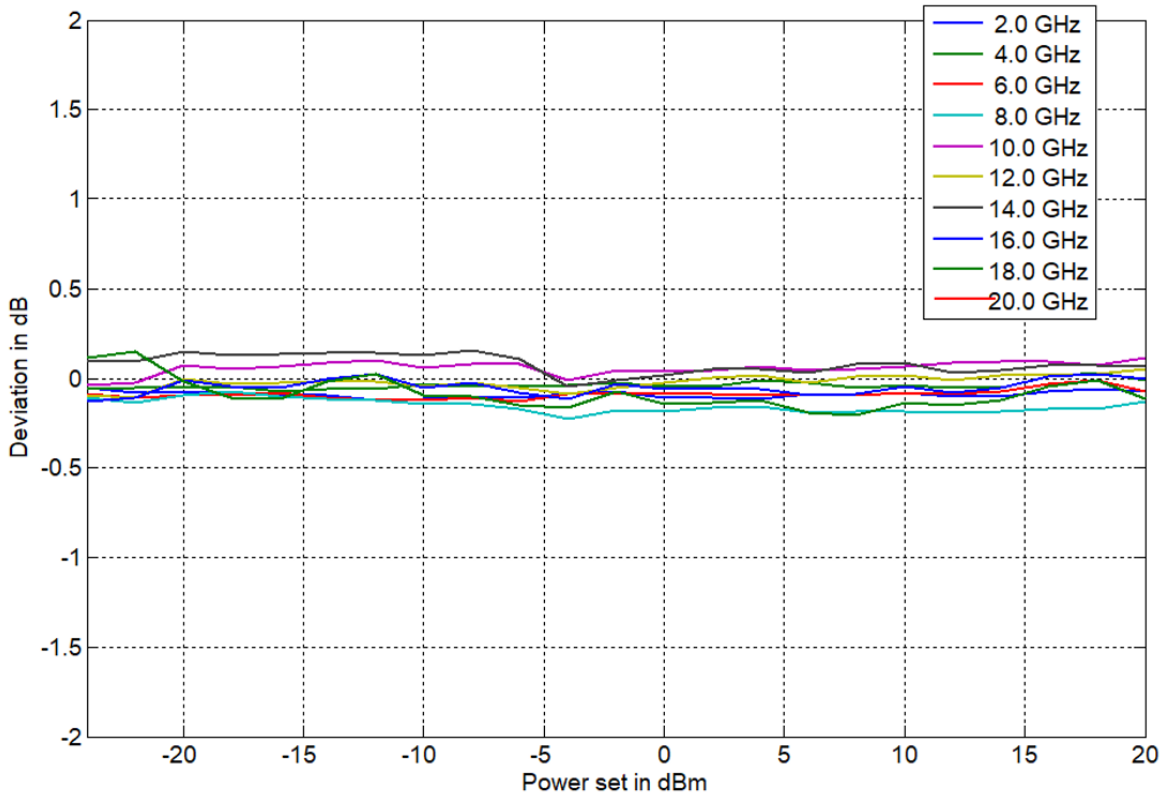

Figure 12: Typical Output Power Linearity (APULN20)



Modulation Capabilities (Option MOD)

PARAMETER	MIN	TYPICAL	MAX	NOTE
Pulse Modulation				
Modulation source		Internal/ External		
Pulse rise/fall time		5 ns		
On/off ratio (high ON/OFF mode)	70 dB 65 dB	80 dB 75 dB		Pout > +10 dBm, f<18 GHz > 18 GHz
Pulse overshoot			10%	
Pulse delay		20 ns		
Pulse polarity		Normal, inverse		selectable
External input threshold	0.85 V	0.9 V	0.95 V	TTL compatible
External input voltage range	-0.5 V		+5.5 V	TTL compatible
External input hysteresis		60 mV		
Internal pulse generator				
Repetition frequency (PRF)	0.1 Hz		50 MHz	= 1/T
Duty cycle	1 % to 99 % in 1% steps			within specified minimum pulse width
Minimum pulse settling range	100 ns 25 ns 15 ns		20 s	Option NEC or NP Option FS
Pulse Pattern Modulation & Staggered PRF				Using internal pattern generator
Programmable pattern length	2		4096	
Duty cycle	0.05%		99.95%	
Pulse width resolution		5 ns		
Pulse period (T) accuracy		0.00005xT+ 3ns		
Pulse width accuracy		0.00005xT+ 5ns		
Pulse jitter		1 ns		
Polarity		selectable		

Figure 13: APULN40 no options 100 ns Pulse Modulation - 40 GHz Carrier Frequency

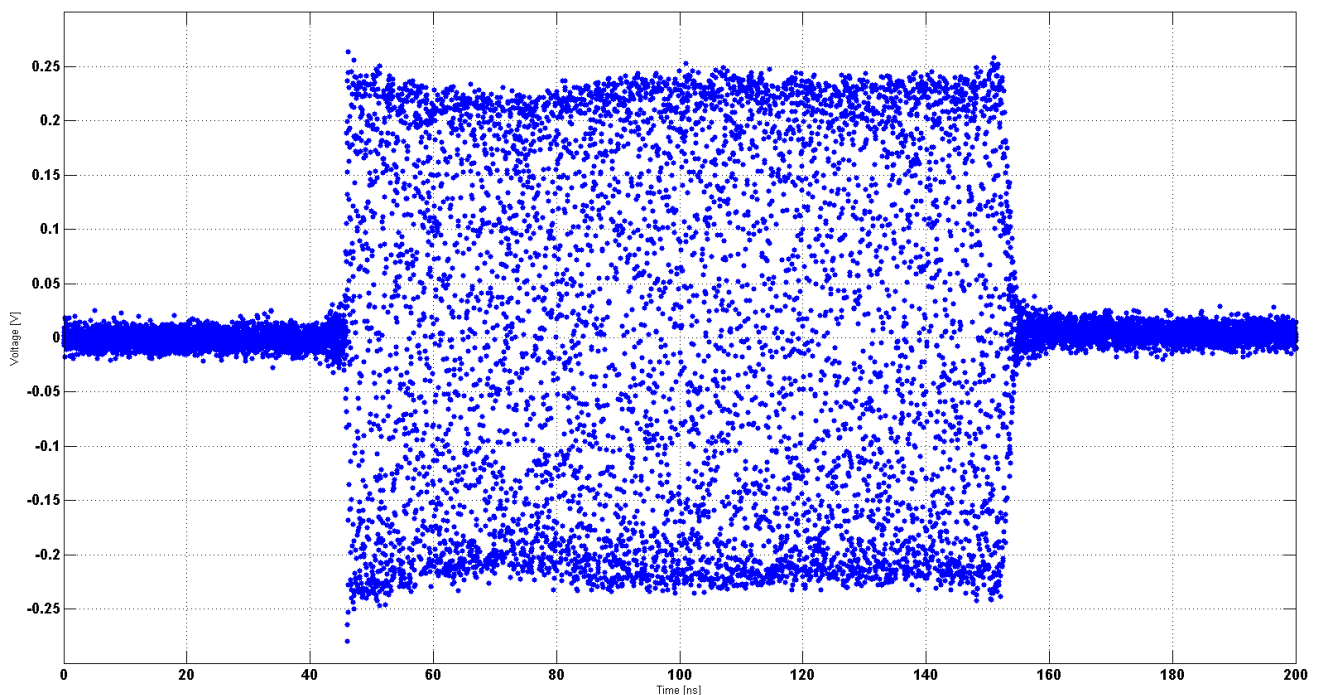

Figure 14: APULN40 option NP or NEC Pulse Modulation 30 ns - 40 GHz Carrier Frequency

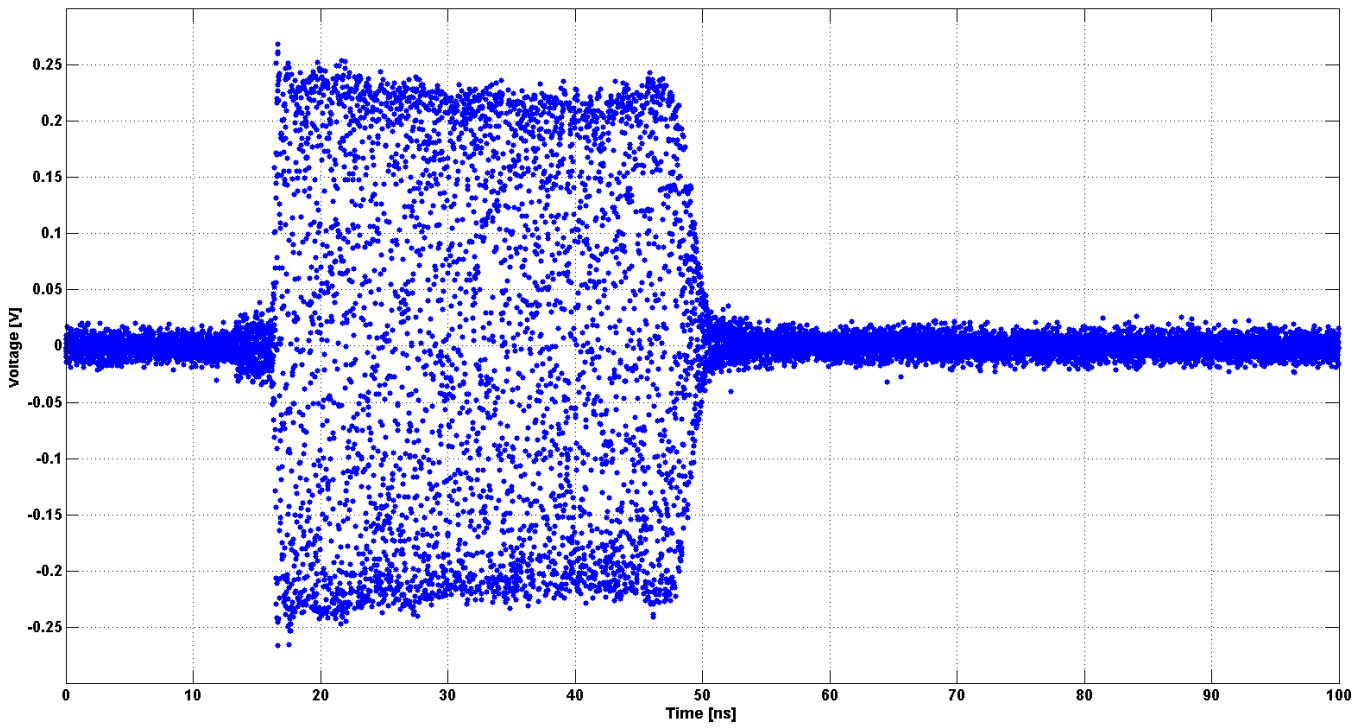
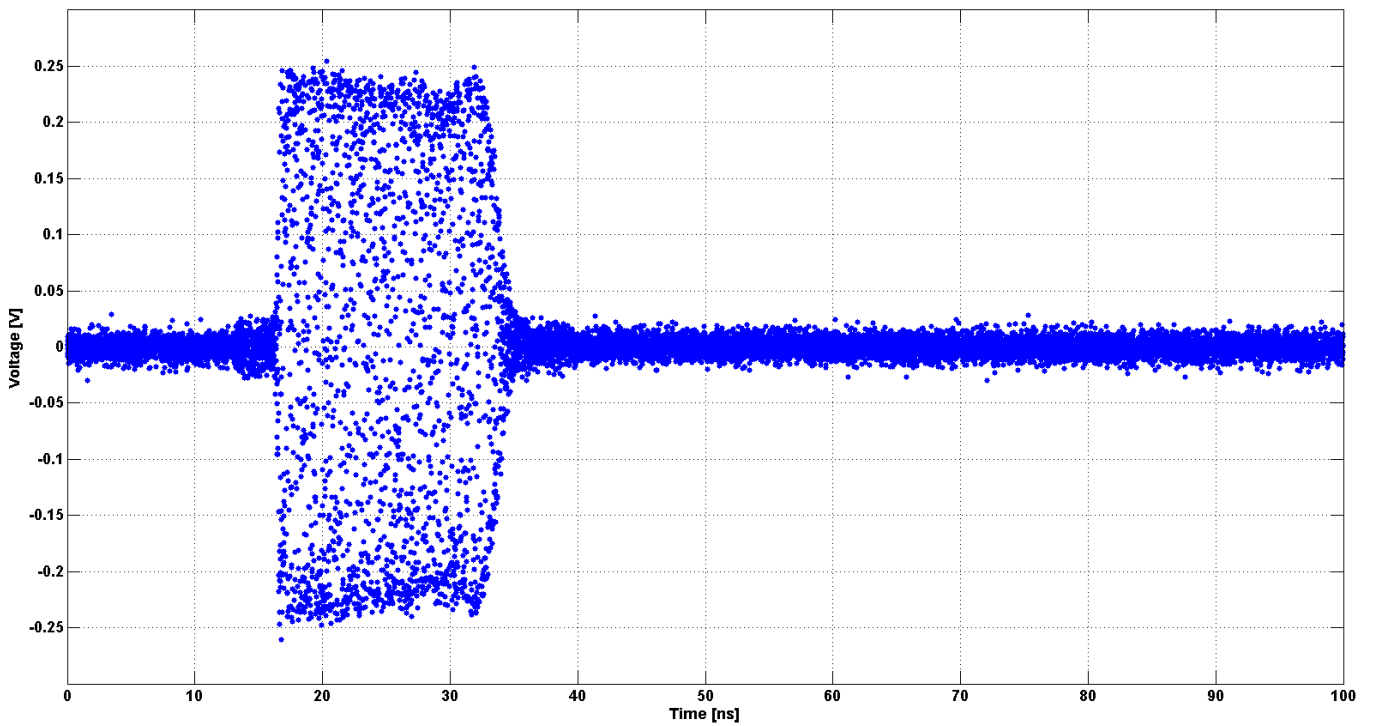

Figure 15: APULN40 option FS Pulse Modulation 20 ns - 40 GHz Carrier Frequency



Chirped Pulse Modulation (Options MOD and FS / NEC)

PARAMETER	MIN	TYPICAL	MAX	NOTE
Modulation source		Internal		
Chirp span	1 Hz		3 %	of RF
Chirp rate	1 Hz		100 kHz	
Pulse width	10 μs 10 μs 500 μs 10 μs 500 μs		1 sec	Option FS Option NEC, f<31.8 GHz, BW<2.2 GHz Option NEC, f<31.8 GHz, BW>2.2 GHz Opt.NEC, f>31.8 GHz, BW<0.55 GHz Opt.NEC, f>31.8 GHz, BW>0.55 GHz
Chirp slope			0.5% / μs	of RF
Chirp mode		Linear, exponential, up, down, bidirectional		

Amplitude Modulation

PARAMETER	MIN	TYPICAL	MAX	NOTE
Modulation source		Internal		
Modulation Depth	0%		80%	Settable to 95%
Deviation accuracy		2%	4%	1 kHz rate, 30% depth
Deviation resolution		1%		
Distortion (THD)		1%	3%	1 kHz rate, 30% depth
Modulation rate	0.1 Hz		30 kHz	
Modulation waveforms	Sine			

Frequency Modulation

PARAMETER	MIN	TYPICAL	MAX	NOTE
Modulation source		Internal/ External		
Maximum Frequency deviation (peak)		N · 200 MHz		< 1.25 GHz (N=1) 1.25 GHz to 2.5 GHz (N=0.125) 2.5 GHz to 5 GHz (N=0.25) 5 GHz to 10 GHz (N=0.5) 10 GHz to 20 GHz (N=1) 20 GHz to 40 GHz (N=2)
Deviation accuracy		0.50%	2%	
Distortion (THD)		< 1 %		1 kHz rate, 10 kHz deviation
Modulation rate	0.1 Hz		80 kHz	
Modulation waveforms	Sine			
External input voltage range	0 V		+10 V	Input voltage must be positive
External input termination		600 Ohms		Internal termination
External input coupling		AC		Cutoff 1 Hz typical (-3 dB) DC coupling on request

Phase Modulation

PARAMETER	MIN	TYPICAL	MAX	NOTE
Modulation source		Internal/ External		
Phase deviation (peak)	0		300 · N · rad	
Deviation accuracy		0.50%	2%	
Modulation rate	0.1 Hz		80 kHz	
Modulation waveforms	Sine			

Distortion (THD)	< 1%	1 kHz rate & N x rad deviation	Distortion (THD)	< 1%
External input voltage range	0 V		+10 V	Input voltage must be positive
External input termination		600 Ohms		Internal termination
External input coupling		AC		Cutoff 1 Hz typical (-3 dB)

Sweeping Capability

PARAMETER	MIN	TYPICAL	MAX	NOTE
Sweep Parameters	Frequency, power, phase, list			
Sweep Types	Linear, logarithmic, random			
Step time (t_{step})	500 μ s 30 μ s		19998 s	Option FS Option NEC
f < 31.8 GHz, fstep < 2.2 GHz	30 μ s			Option NEC
f < 31.8 GHz, fstep > 2.2 GHz	100 μ s			Option NEC
f > 31.8 GHz, fstep < 0.55 GHz	30 μ s			Option NEC
f > 31.8 GHz, fstep > 0.55 GHz	500 μ s			Option NEC
Settling time (t_{inv})			15 μ s	To stabilize phase and amplitude, depends on frequency step
Time resolution		5 ns		
Timing accuracy per point		5 ns		

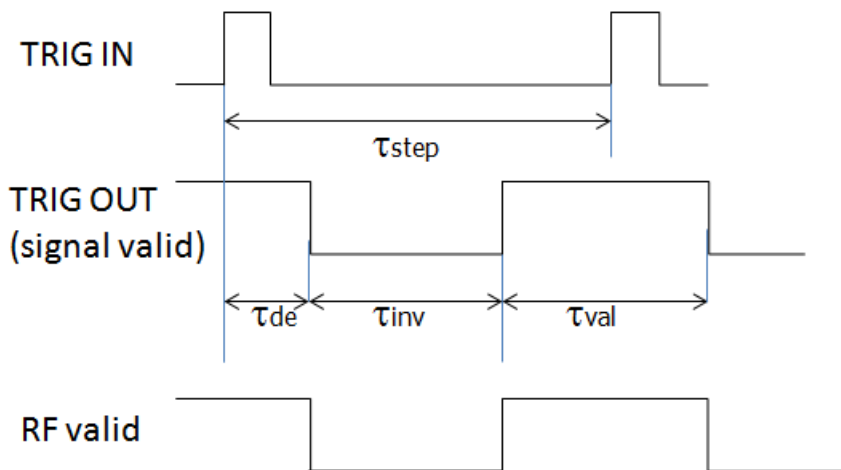

Frequency Reference

PARAMETER	MIN	TYPICAL	MAX	NOTE
Internal Reference Frequency		100 MHz 10 MHz		Option LN
Temperature stability 0 to 50 °C			± 100 ppb ± 20 ppb	Option LN
Aging first year			1 ppm 0.03 ppm 0.02 ppm	Option LN Option LN+
Aging per day			5 ppb 0.5 ppb	after 30 days operations Option LN
Warm-up time		5 min		
Output of internal reference		100 MHz 10/100 MHz		Option LN
Output power		0 dBm		
Output impedance		50 Ohms		
Bypass Internal reference Input		100 MHz		High phase synchronous mode *Options LN/LN+ are bypassed

Phase Lock to External Reference				Option VREF *Options LN/LN+ are bypassed
Bypass Mode	5	10 MHz integer MHz 100 MHz	250	
Reference input level				
10 MHz or 1-250 MHz	-5 dBm	0 dBm	+10 dBm	
100 MHz	5 dBm		+15 dBm	
Lock Range				
10 MHz or 1-250 MHz			±1.5 ppm	
100 MHz			>100 ppm	
Reference input impedance		50 Ohms		



Trigger

PARAMETER	MIN	TYPICAL	MAX	NOTE
Trigger Types	Continuous, single (point), gated, gated direction			
Trigger Source	external, bus (LAN, USB)			
Trigger Modes	Continuous free run, trigger and run, reset and run			
Trigger uncertainty		10 ns		
External trigger delay	50 ns		40 s	settable
External delay resolution		5 ns		
Trigger Modulo	1		255	Execute only on Nth trigger event
Trigger Polarity	Rising, falling			
External trigger input threshold	0.85 V	0.9 V	0.95 V	TTL compatible
External trigger input voltage range	-0.5 V		+5.5 V	TTL compatible
External trigger input hysteresis		60 mV		



Multi-Purpose Output (FUNC OUT): Output is TRIG OUT at rear panel

PARAMETER	MIN	TYPICAL	MAX	NOTE
MULTIFUNCTION GENERATOR	sine, triangle, square wave			
Frequency range	1 Hz 1 Hz		3 MHz 1 MHz 50 kHz	sine triangle square
Frequency resolution		0.1 Hz		
Output voltage amplitude peak-peak	10 mV	5V	2 V	Sine, triangle Square (CMOS output)
Harmonic Distortion		1 %		< 100 kHz, 1 Vpp
Output impedance		50 Ohms CMOS		Sine, triangle square wave
VIDEO OUTPUT (of internal pulse modulator)				
Output		CMOS		
Period	30 ns		50 s	
Pulse width	15 ns		50 s	
RF delay		10 ns		
TRIGGER OUT Synchronization mode for multiple sources				
Modes	Trigger on sweep start Trigger on each point Signal Valid			

Figure 16: Desktop App GUI

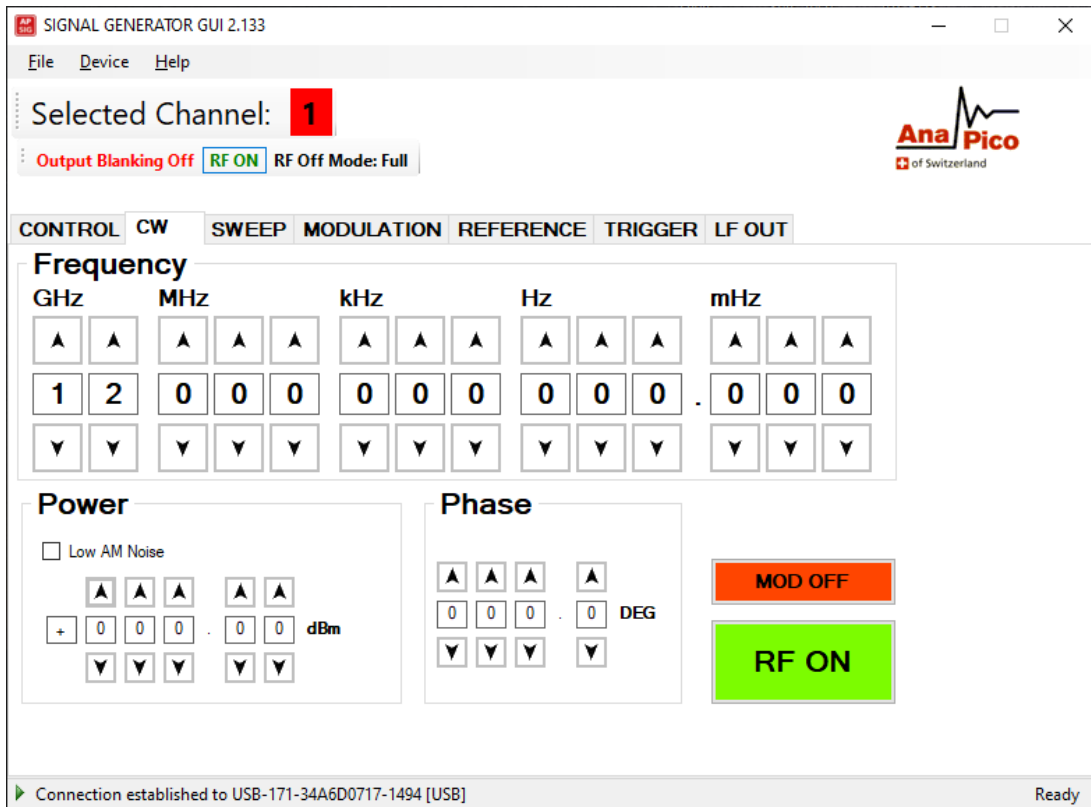
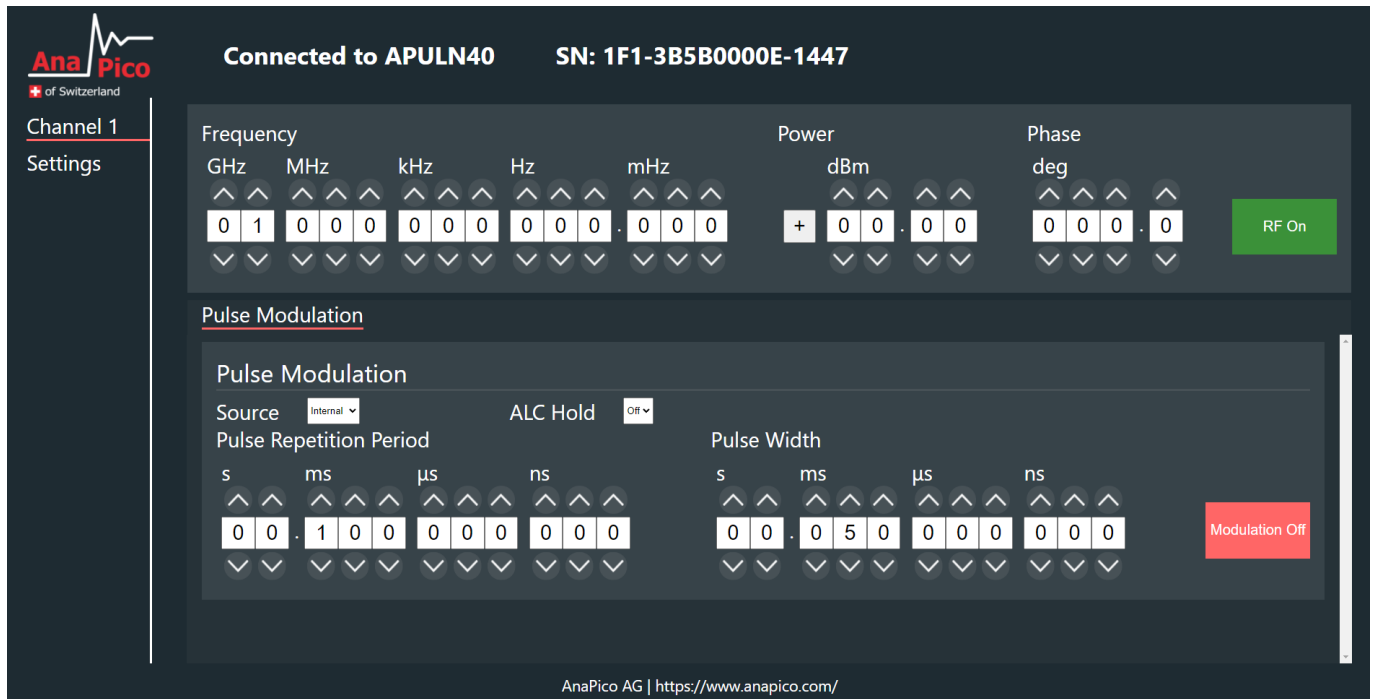

Figure 17: Web Browser GUI



CONNECTORS, KEYS

Front panel:

1. Color touch display
2. RF output:
 - APULN40: K (2.92 mm) female
 - APULN12, 20, 26: SMA female
3. Rotary knob

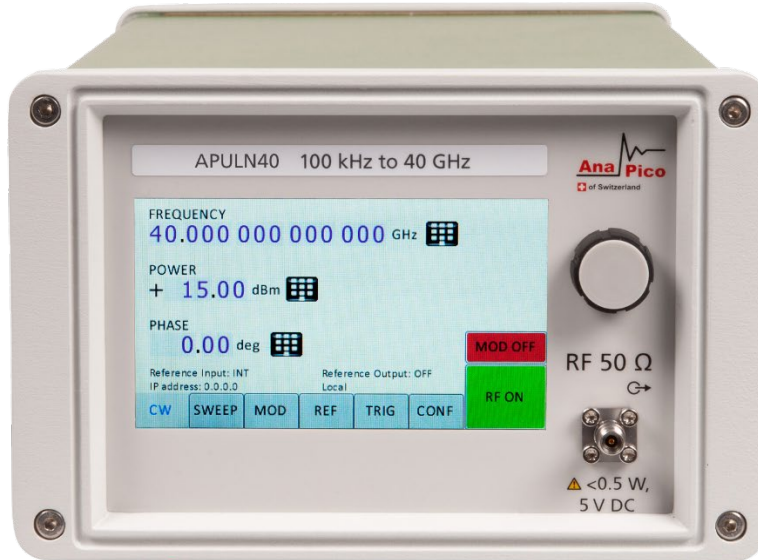

Rear panel:

1. TRIG IN: Trigger input: BNC female
2. TRIG OUT: Trigger output: BNC female
3. REF OUT: Internal reference output: BNC female
4. REF IN: External reference input: BNC female
5. MOD IN: Modulation input for FM/PM: BNC female
6. PULSE IN: Pulse modulation input: BNC female
7. LAN connection: RJ-45
8. USB 2.0 host and device
9. GPIB: IEEE-488.2, 1987 with listen and talk
10. DC Power plug (24 V, 3 A)
11. DC power switch



ORDERING INFORMATION



HOST MODEL	PRODUCT	DESCRIPTION
APULN12	APULN12	100 kHz – 12.75 GHz
APULN20	APULN20	100 kHz – 20 GHz
APULN26	APULN26	100 kHz – 26 GHz
APULN40	APULN40	100 kHz – 40 GHz
APULNXX	Option LN	Enhanced close in phase noise & frequency stability
APULNXX	Option LN+	Enhanced close in phase noise & further enhanced long term frequency stability
APULNXX	Option FS	Ultra-fast switching speed
APULNXX	Option NEC	Fast switching speed, narrow pulse, chirp (no export control required)
APULNXX	Option NP	Narrow pulse modulation
APULNXX	Option MOD	Analog modulation
APULNXX	Option FILT	Harmonic filtering (not in combination with option PE4)
APULNXX	Option 8K	Frequency range extension to 8 kHz
APULNXX	Option VREF	Variable external reference
APULN12/20/26	Option PE4-12/20/26	Electrical step attenuator (12, 20 & 26 GHz version) (not in combination with option FILT)
APULN40	Option PE4-40	Electrical step attenuator (40 GHz version) (not in combination with option FILT)
APULN12/20	Option PE-12/20	Mechanical step attenuator down to -90 dBm (12 & 20 GHz version)
APULN26/40	Option PE-26/40	Mechanical step attenuator down to -90 dBm (26 & 40 GHz version)
APULN12/20/26	Option PE2-12/20/26	Mechanical step attenuator down to -120 dBm (12, 20 & 26 GHz version)
APULN40	Option PE2-40	Mechanical step attenuator down to -120 dBm (40 GHz version)
APULNXX	Option EB	External power bank adapter cable
APULNXX	Option GPIB	GPIB interface
APULNXX	Option RM	19" 3HU rack-mount kit
APULNXX	Option 1URM	19" 1HU rack-mount module
APULNXX	Option REAR	Move output to rear panel
APULNXX	Option FLASH	MicroSD card slot for removable SD memory
APULNXX	Option DATA	Commercial Calibration Certificate with test data
APULNXX	Option IEC	IEC 17025 calibration with certificate
APULNXX	Option Bag	Portable Bag
APULNXX	Option WE	One year warranty extension (standard: 2 years)
APULNXX	Option ReCal	Recalibration with certificate (recommended: 2 years interval)
APULNXX	Option Retrofit	Applies when options are back-ordered

GENERAL CHARACTERISTICS

Remote programming interfaces

- Ethernet 100BaseT LAN interface,
- USB 2.0 host & device
- GPIB (IEEE-488.2,1987) with listen and talk (optional)
- Control language SCPI Version 1999.0

Power requirements: 24V ± 3.0 VDC; 25 W maximum

AC adapter supplied: 100-240 VAC in/ 24 V 4.0 A DC out

Environmental: (Levels similar to MIL-PRF-28800F Class 3/4)

Samples of this product have been type-tested to be robust under the environmental conditions of storage, transportation, and end-use with different temperature, humidity, shock, vibration, altitude, and power line conditions.

Operating temperature range: 0 to 45 °C

Storage temperature range: -40 to 70 °C

Operating and storage altitude: up to 15,000 feet (4600 m)



EMC: complies and EMC regulations and directives for emission and immunity to interference (EN 61326-1 Industrial, EN/IEC 61326-2-1).

Safety: complies with applicable Safety regulation in line with IEC/EN 61010-1

This product complies with directive 2011/65/EU

Weight: 2.5 kg (6 lbs) net, ≤ 4 kg (8 lb.) with ship-ready package

Dimensions: 106 mm H x 172 mm W x 290 mm L / 4.21 in H x 6.77 in W x 11.42 in L, incl. connectors

Recommended calibration cycle: 24 months



Document History

Version/Status	Date	Author	Notes
V123	2019-02-28	jk	New layout
V124	2019-03-21	jk	Min. Pulse width w. option FS
V125	2019-10-01	jk	Pulsed chirps w. option FS
V126	2019-10-21	jk	Max power settings revised
V130	2020-01-26	jk	Option FILT added
V131	2020-05-21	jk	Option 8K added
V132	2020-07-21	jk	Refined power ranges, plots added
V133	2021-02-25	db	Pulse and trigger input electrical specifications
V134	2021-05-10	db	AM, FM, PM input electrical specifications
V135	2021-06-03	yg	Adding PE2, PE, changing o/p power ranges
V136	2021-07-10	jk	Added max values for phase noise, spurious
V137	2022-05-28	yg/ah	Removed option LH, removed ext. AM mode, added LN+ specs
V138	2022-06-28	jk	Added option NP
V139	2022-07-05	jk	APULN20 max power ratings refined due to improved harmonic filtering
V140	2022-08-05	jk	Added option NEC
V141	2022-10-25	jk	Option NP refined specifications
V142	2022-11-11	jk	Phase Noise data refined
V143	2023-03-27	db	Added FILT + PE max power specs
V144	2023-05-15	jk / ee	New plots / updated photos
V145	2024-02-07	ap/mh/yg	External reference mode amendment

AnaPico of Switzerland

Europa-Strasse 9
8152 Glattbrugg
Switzerland

Phone: +41 44 440 00 50
E-Mail: sales@anapico.com

www.anapico.com
www.anapico.com/downloads/

