



DATASHEET APVSG(-X) Specification V1.31

Single- and Multi-Channel Ultra-Agile Vector Signal Generators

Models up to 4, 6, 12, 20, and 40 GHz



CONTENTS

Definitions	4
Introduction	4
Ultra-Agile Vector Signal Generator	4
Facts & Figures & Specifications	5
Frequency Parameters / Range	5
Frequency Reference	5
Level Performance	6
Power Level Uncertainty	7
Reverse Power Protection and VSWR	8
Phase Noise	9
Spectral Purity	11
Sweeping Capability	12
Phase Coherence	13
Phase-Coherent Modes	13
Multi-Channel Performance	14
Multi-Device Performance (Option SYNC)	14
Analog Modulation (Option MOD)	15
Pulse Modulation	15
Amplitude Modulation	16
Frequency Modulation	17
Phase Modulation	18
Pulse Descriptor Word (Option PDW)	18
I/Q Modulator	19
Internal I/Q Baseband Generator	20
Internal Vector Modulation (Option IVM)	21
Multicarrier Generation (Option IVM)	23
Avionics Modulation (Option AVIO)	24
Additive White Gaussian Noise (Option AWGN)	25
Trigger Capability	26
External Multi-Function Inputs	26
External Multi-Function Outputs	26
Fast Control Port (Option FCP)	26
External Analog Inputs (Option AIQ)	27
SD Card (Option SD)	27
Connectors	28
Front Panel (Single Channel Model):	28
Rear Panel (Single Channel Model):	28
Front Panel (2U Multi-Channel Model):	29

Rear Panel (2U Multi-Channel Model):	29
Ordering Information	30
General Characteristics.....	31
Document History	32
Notes	33

DEFINITIONS

• The specifications in the following pages describe the warranted performance of the instrument for 23 (± 5 or ± 3 °C, see p. 24 °C after 2 hours storage at room temperature a 30-minute warm-up period.

Typical: Expected mean values, not warranted performance

Min and max: Parameter range that is guaranteed by product design, and/or production tested. Warranted performance specifications include guard-bands to account for the expected statistical performance distribution, measurement uncertainties, and changes in performance due to specified environmental conditions, aging and drift.

INTRODUCTION

• Ultra-Agile Vector Signal Generator

The APVSG is an ultra-fast-switching vector-modulated signal generator series covering continuous frequency ranges from 10 MHz (100 kHz with option 100K) to 4, 6, 12, 20, or 40 GHz, respectively, with 0.001 Hz resolution, and 400 MHz RF modulation bandwidth.

The APVSG-X is the corresponding multi-channel product series – up to 4 channels per device. This specification applies to single channel models as well as to the independent channels of multi-channel models.

A high performance internal I/Q modulator enables customized waveforms as modulation signals and supports variety of modulation schemes including avionics modulation. The digital I/Q modulator ensures excellent carrier suppression and a very high image suppression.

The standard APVSG enables ultra-fast CW frequency sweeping, chirping, intra-pulse modulation, pulse shaping with very low phase noise.

Multi-channels models exhibit exceptionally high phase stability between channels synchronized by the same common reference.

Among others, the following use cases are supported:

- Upload multiple formats of I/Q Data into APVSG Memory. An APVSG GUI supports data formats from various vendors. The internal RAM can store up to 512 MS (32 bits per I/Q sample) of I/Q data. The APVSG internal AWG can play selected sections of the RAM upon a user trigger.
- Use APVSG to synthesize and play predefined digital modulation formats (option IVM)
- Use the analog I & Q inputs (option AIQ) with up to 50 MHz analog bandwidth.
- Use FCP interface (option FCP) to:
 - live stream digital I/Q data.
 - instantaneously switch between pre-loaded I/Q data segments.
 - control for ultra-fast frequency hopping (additionally, option UFS required).

All APVSGs operate with an ultra-stable temperature compensated frequency reference (OCXO) that can be phase-locked to an external reference.

The compact device can be controlled by the touch display and a PC user interface.

This information is subject to change without notice.

This datasheet is valid for devices with serial number from xxx-xxx6x4xxx-xxxx and above.

FACTS & FIGURES & SPECIFICATIONS

Frequency Parameters / Range

PARAMETER	MIN	TYPICAL	MAX	NOTE
Frequency Range	100 kHz			Option 100K
	10 MHz		4 GHz 6 GHz 12 GHz 20 GHz 40 GHz	APVSG04 APVSG06 APVSG12 APVSG20 APVSG40
Settable Frequency Range ¹	100 kHz			Option 100K
	10 MHz		4.15 GHz 6.6 GHz 12 GHz 20 GHz 43.5 GHz	APVSG04 APVSG06 APVSG12 APVSG20 APVSG40
Phase Adjustment Range	0 deg		360 deg	
Frequency Resolution		0.001 Hz		
Phase Resolution		0.01 deg		
Frequency & Amplitude Switching Time		500 μs 1 μs 2 μs		APVSG04, APVSG20, APVSG40 APVSG04 Option UFS APVSG20, APVSG40 Option UFS

Frequency Reference

PARAMETER	MIN	TYPICAL	MAX	NOTE
Internal Reference Frequency		100 MHz 10 MHz		Options LN / LN+
Initial Calibrated Accuracy			±10 ppb	At 23 ± 3 °C
Temperature Stability 0 to 50 °C			±100 ppb ±20 ppb	Options LN / LN+
Aging after 1st Year			1 ppm 30 ppb 20 ppb	Option LN Option LN+
Aging per Day			5 ppb 0.5 ppb	after 30 days operation Options LN / LN+
Warm-up Time		5 min		
Reference Output				
Output Frequency		10 MHz, 100 MHz		
Output Power		0 dBm 9 dBm		10 MHz 100 MHz
Output Impedance		50 Ω		
External Reference Input				
Input Frequency Range	5 MHz	10 MHz	250 MHz	Option VREF
Frequency Resolution		1 MHz		Option VREF
Input Impedance		50 Ω		
Input Power Level	-5 dBm	0 dBm	+10 dBm	
Lock Range	±1.5 ppm			

¹ Performance above frequency range not guaranteed



Level Performance

PARAMETER	MIN	TYPICAL	MAX	NOTE
Output Power Level APVSG				
100 kHz to 100 MHz	-20 dBm		+15 dBm	Option 100K
Output Power Level APVSG04				
10 to 100 MHz	-20 dBm -55 dBm -90 dBm -120 dBm		+10 dBm +8 dBm +10 dBm +10 dBm	Option PE4 Option PE2 Option PE
0.1 to 4 GHz	-20 dBm -55 dBm -90 dBm -120 dBm		+18 dBm +17 dBm +17 dBm +17 dBm	Option PE4 Option PE2 Option PE
Output Power Level APVSG06				
10 to 100 MHz	-20 dBm -55 dBm -90 dBm -120 dBm		+10 dBm +8 dBm +10 dBm +10 dBm	Option PE4 Option PE Option PE2
0.1 to 6 GHz	-20 dBm -55 dBm -90 dBm -120 dBm		+15 dBm +15 dBm +15 dBm +15 dBm	Option PE4 Option PE Option PE2
Output Power Level APVSG12				
10 to 100 MHz	-20 dBm -55 dBm -90 dBm -120 dBm		+10 dBm +8 dBm +10 dBm +10 dBm	Option PE4 Option PE Option PE2
0.1 to 12 GHz	-20 dBm -55 dBm -90 dBm -120 dBm		+15 dBm +15 dBm +15 dBm +15 dBm	Option PE4 Option PE Option PE2
Output Power Level APVSG20				
10 to 100 MHz	-20 dBm -90 dBm -120 dBm		+10 dBm +10 dBm +10 dBm	Option PE Option PE2
0.1 to 20 GHz	-20 dBm -90 dBm -120 dBm		+17 dBm +16 dBm +16 dBm	Option PE Option PE2
Output Power Level APVSG40				
10 to 100 MHz	-20 dBm -90 dBm -120 dBm		+10 dBm +10 dBm +10 dBm	Option PE Option PE2
0.1 to 20 GHz	-20 dBm -90 dBm -120 dBm		+17 dBm +16 dBm +16 dBm	Option PE Option PE2
20 to 26 GHz	-20 dBm -90 dBm -120 dBm		+16 dBm +15 dBm +14 dBm	Option PE Option PE2
26 to 40 GHz	-20 dBm -90 dBm -120 dBm		+15 dBm +13 dBm +12 dBm	Option PE Option PE2
Power Resolution		0.01 dB		

Figure 1: Maximum Output Power APVSG04

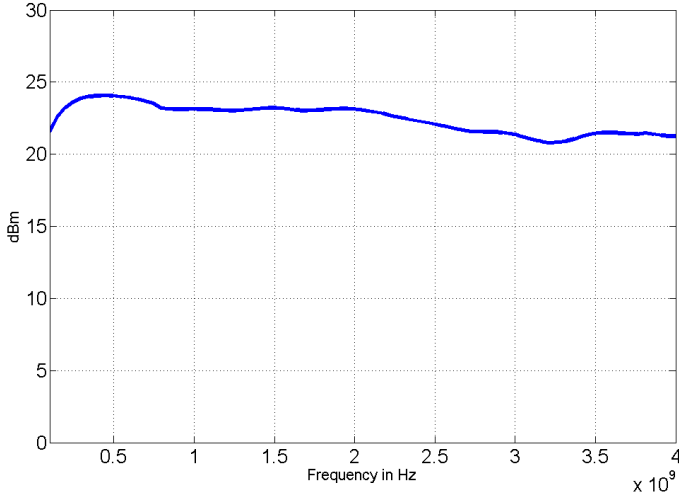

Figure 2: Maximum Output Power APVSG06

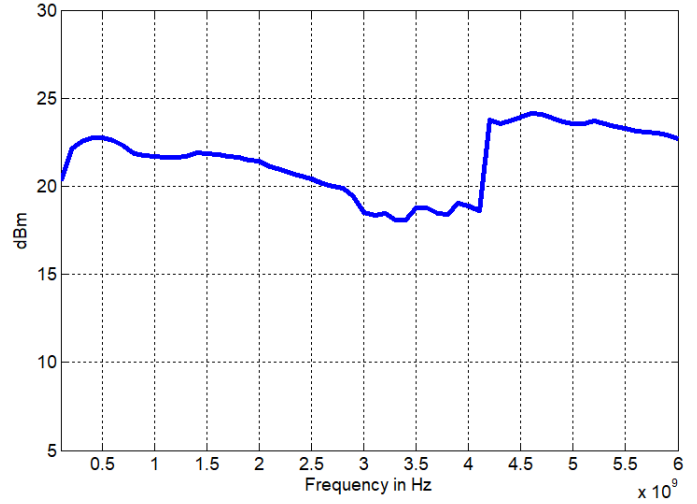
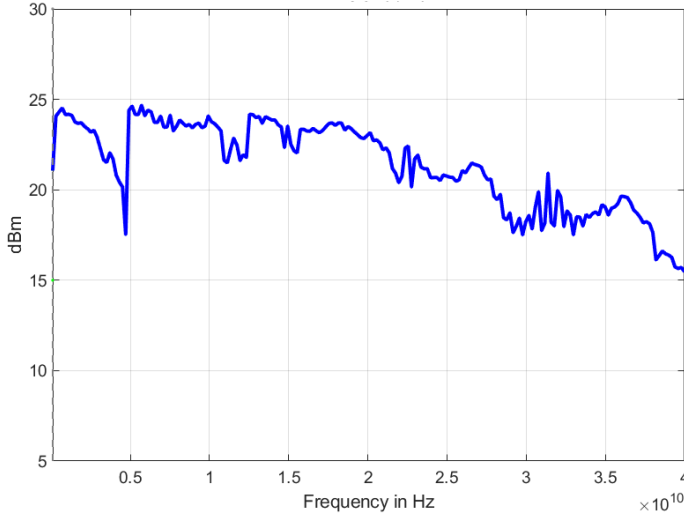

Figure 3: Maximum Output Power APVSG20/40



Power Level Uncertainty

PARAMETER	MIN	TYPICAL	MAX	NOTE
< 4 GHz		0.25 dB	0.7 dB	> -20dBm
4 to 6 GHz		0.3 dB	1.0 dB	
6 to 20 GHz		0.3 dB	1.3 dB	
20 to 40 GHz			1.5 dB	
< 4 GHz		0.3 dB	0.8 dB	Pmin to -20 dBm
4 to 6 GHz		0.35 dB	1.2 dB	
6 to 20 GHz		0.4 dB	1.4 dB	
20 to 40 GHz		0.5 dB	1.6 dB	

Figure 4: Power Level Accuracy APVSG12

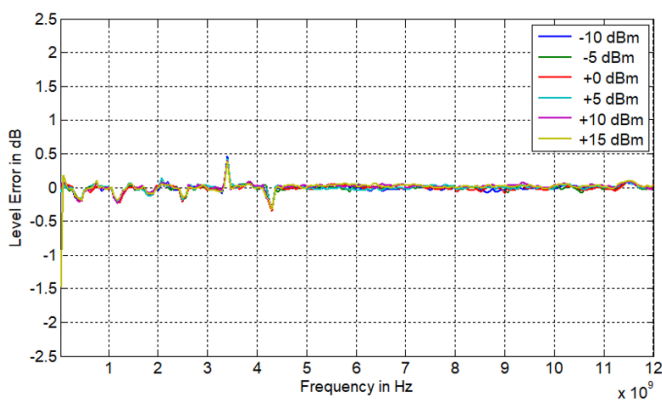

Figure 5: Power Level Accuracy APVSG12

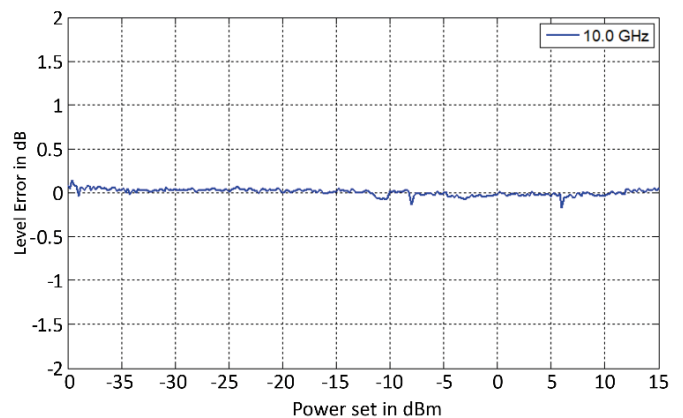

Figure 6: Power Level Accuracy APVSG40

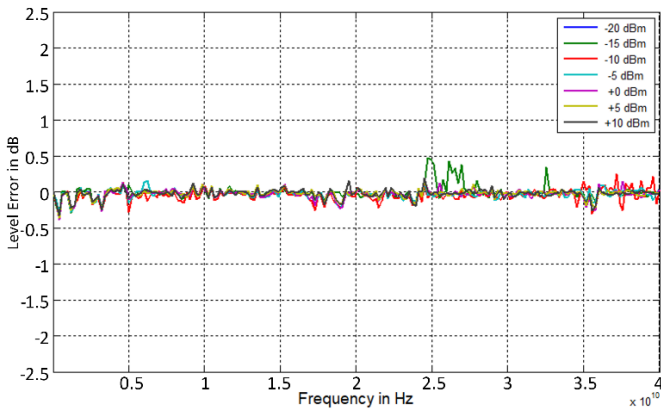
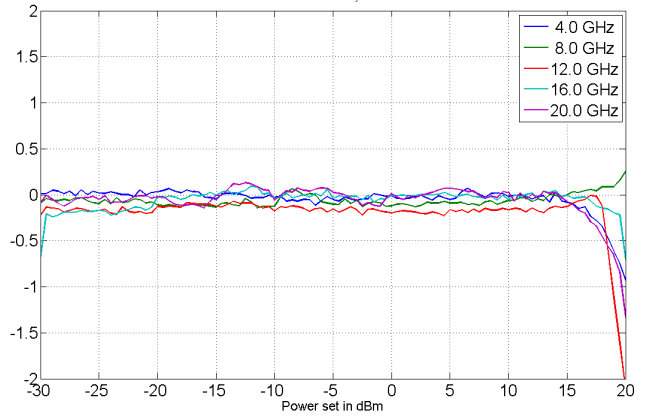

Figure 7: Power Level Accuracy APVSG20



Reverse Power Protection and VSWR

PARAMETER	MIN	TYPICAL	MAX	NOTE
DC Voltage			±10 V	
RF Power			26 dBm	
Output Impedance		50 Ω		
VSWR		1.8		See Figure 14

Figure 8: Typical VSWR APVSG04

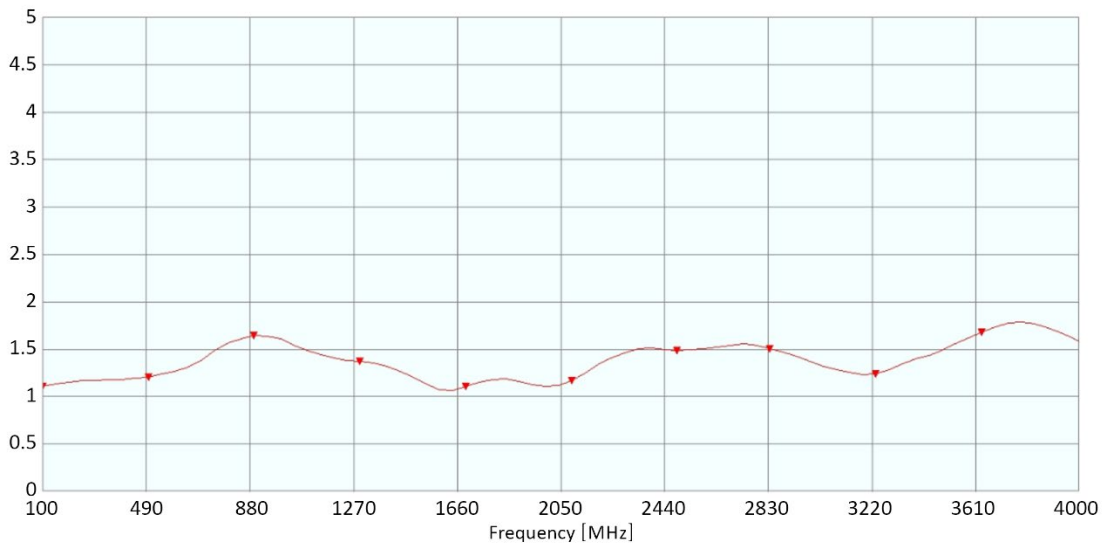
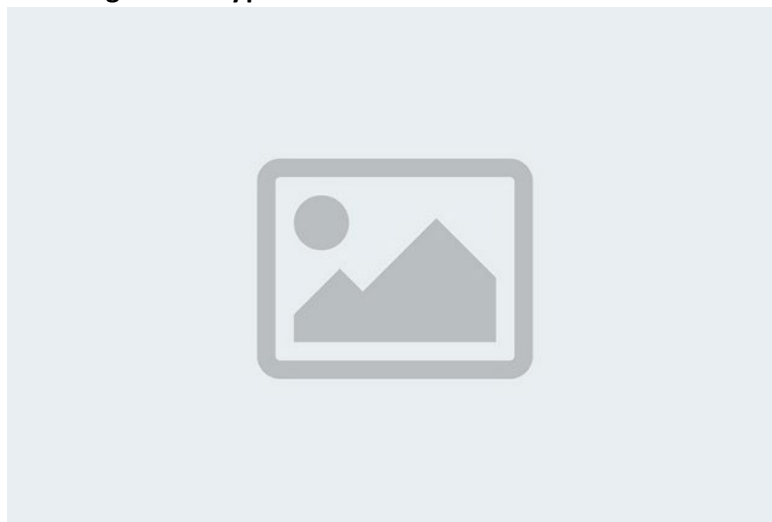

Figure 9: Typical VSWR APVSG12 & APVSG20



Phase Noise

PARAMETER	MIN	TYPICAL	MAX	NOTE
SSB Phase Noise at 1 GHz, 10 dBm				See Figures 1, 2
at 10 Hz from Carrier		-87 dBc/Hz	-84 dBc/Hz	Option LN
at 1 kHz from Carrier		-130 dBc/Hz		
at 20 kHz from Carrier		-145 dBc/Hz		
at 100 kHz from Carrier		-150 dBc/Hz		
SSB Phase Noise at 4 GHz, 10 dBm				See Figures 1, 2
at 10 Hz from Carrier		-74 dBc/Hz	-74 dBc/Hz	Option LN
at 1 kHz from Carrier		-121 dBc/Hz		
at 20 kHz from Carrier		-133 dBc/Hz		
at 100 kHz from Carrier		-138 dBc/Hz		
SSB Phase Noise at 10 GHz, 10 dBm				See Figures 1, 2
APVSG20G & APVSG40G				See Figures 1, 2
at 10 Hz from Carrier		-66 dBc/Hz	-65 dBc/Hz	Option LN
at 1 kHz from Carrier		-104 dBc/Hz		
at 20 kHz from Carrier		-115 dBc/Hz		
at 10 MHz from Carrier		-118 dBc/Hz		
SSB Phase Noise at 20 GHz, 10 dBm				See Figures 1, 2
APVSG20G & APVSG40G				See Figures 1, 2
at 10 Hz from Carrier		-60 dBc/Hz	-59 dBc/Hz	Option LN
at 1 kHz from Carrier		-104 dBc/Hz		
at 20 kHz from Carrier		-115 dBc/Hz		
at 10 MHz from Carrier		-118 dBc/Hz		

Figure 10: SSB Phase Noise Performance, APVSG20/40, CW without option LN, Pout = 10 dBm

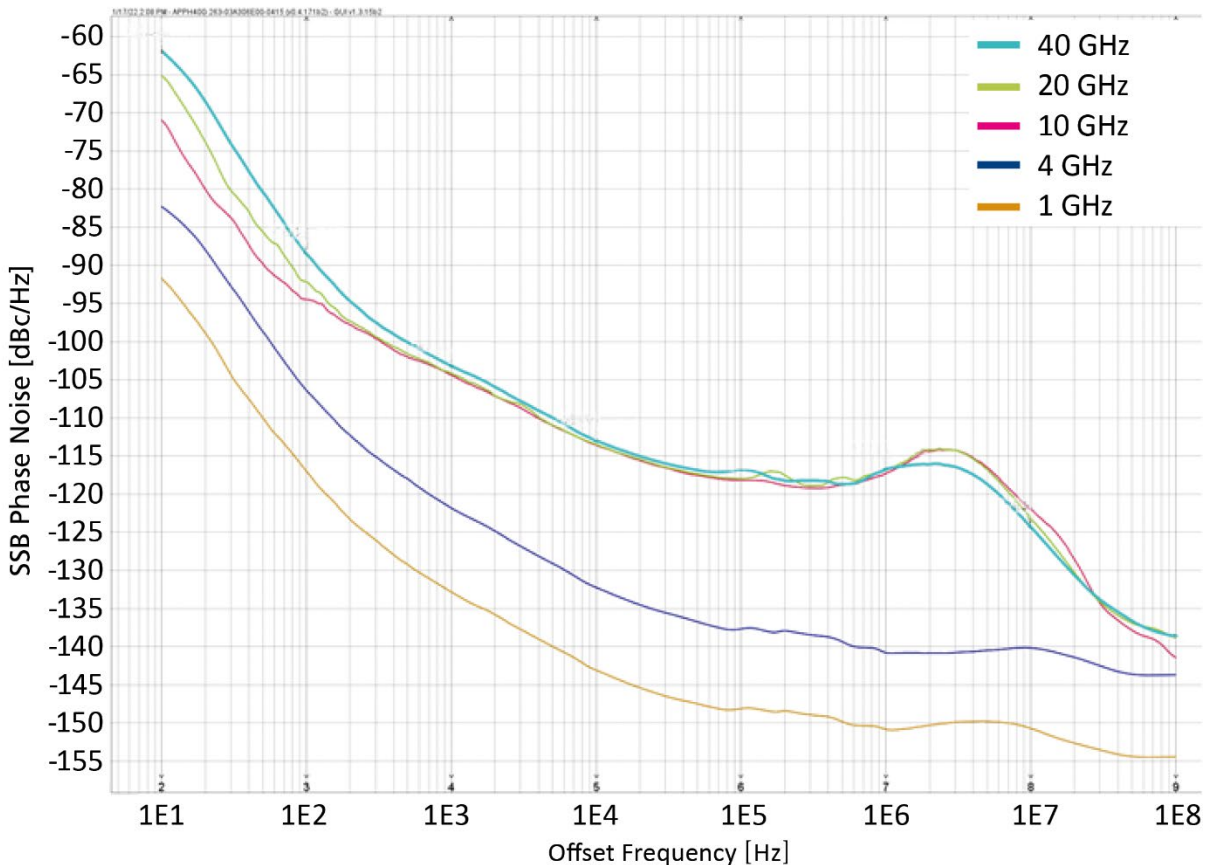

Figure 11:

SSB Phase Noise Performance, APVSGXX, low frequency CW without option LN, Pout = 10 dBm

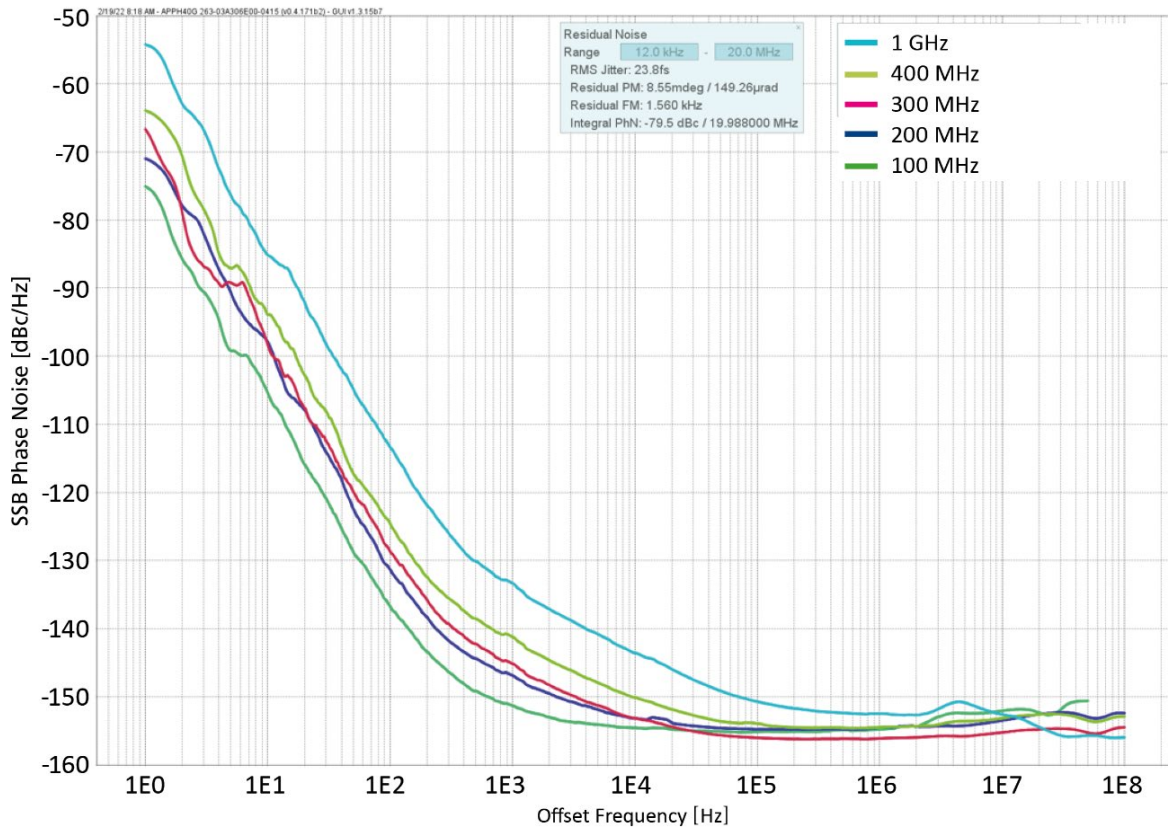
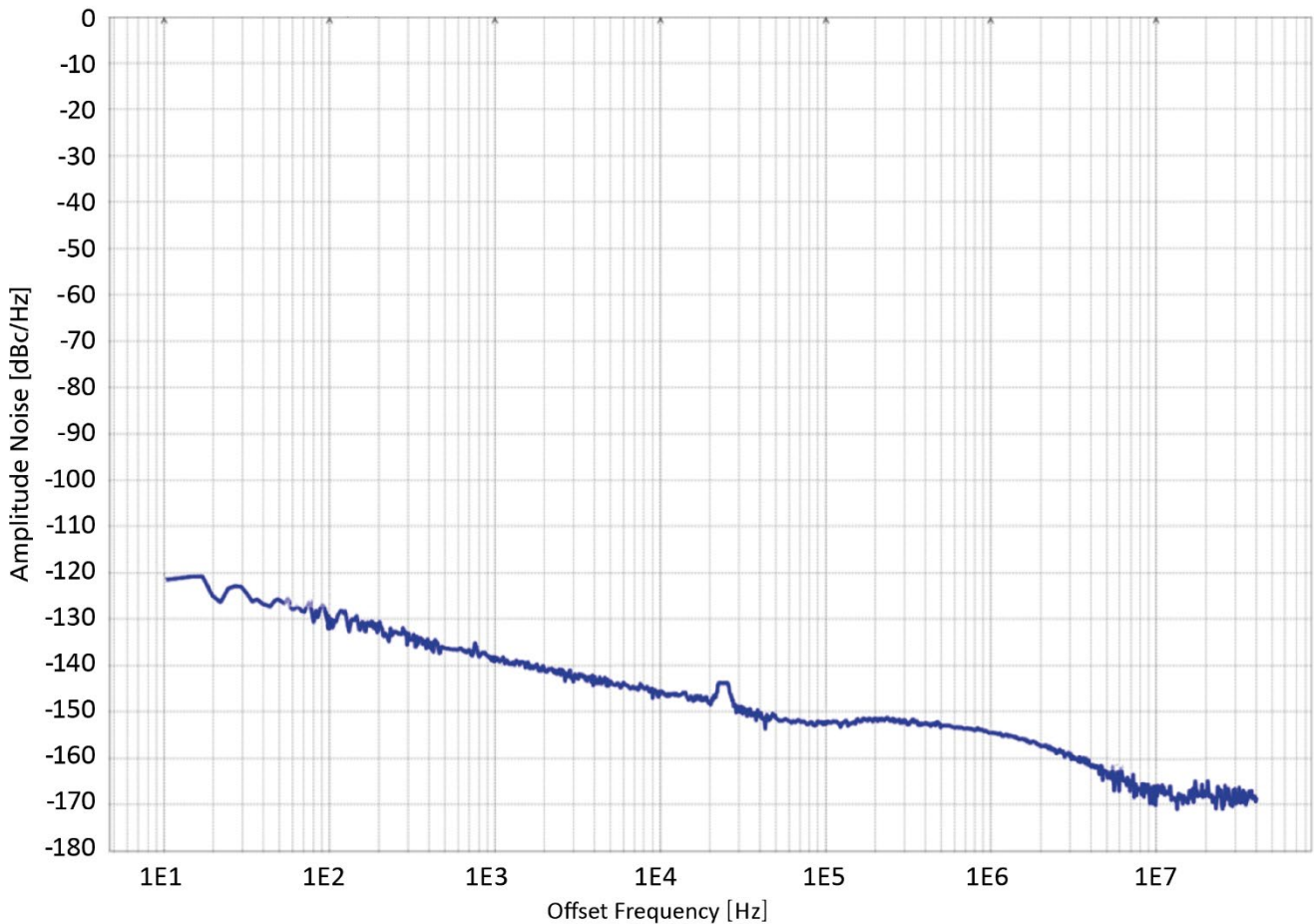

Figure 12: Amplitude Noise, 2 GHz, Pout = 10 dBm



PARAMETER	MIN	TYPICAL	MAX	NOTE
Harmonics @ 0 dBm APVSG04 0.01 to 2 GHz 2 to 4 GHz		-55 dBc -45 dBc	-48 dBc -40 dBc	
Harmonics @ 0 dBm APVSG06 0.01 to 4 GHz 4 to 6 GHz		-45 dBc -35 dBc	-40 dBc -30 dBc	
Harmonics @ 0 dBm APVSG12 0.01 to 4 GHz 4 to 7 GHz 7 to 12 GHz		-45 dBc -35 dBc -55 dBc	-40 dBc -30 dBc -50 dBc	
Harmonics @ 0 dBm APVSG20 0.01 to 4.5 GHz 4.5 to 10.5 GHz >10.5 GHz		-50 dBc -40 dBc -55 dBc	-40 dBc -35 dBc -48 dBc	
Harmonics @ 0 dBm APVSG40 0.01 to 4.5 GHz 4.5 to 20 GHz >20 GHz		-50 dBc -35 dBc -35 dBc	-45 dBc -30 dBc -30 dBc	
Non-Harmonic Spurious (at 0 dBm Output, > 10 kHz Offset)		-90 dBc -80 dBc -80 dBc -70 dBc -60 dBc -55 dBc	-75 dBc -70 dBc -55 dBc -50 dBc -50 dBc -45 dBc	< 1.2 GHz 1.2 to 2.5 GHz 2.5 to 4 GHz 4 to 12 GHz 12 to 20 GHz > 20 GHz

Figure 13: APVSG06 - Harmonic Performance at Pout = 0 dBm

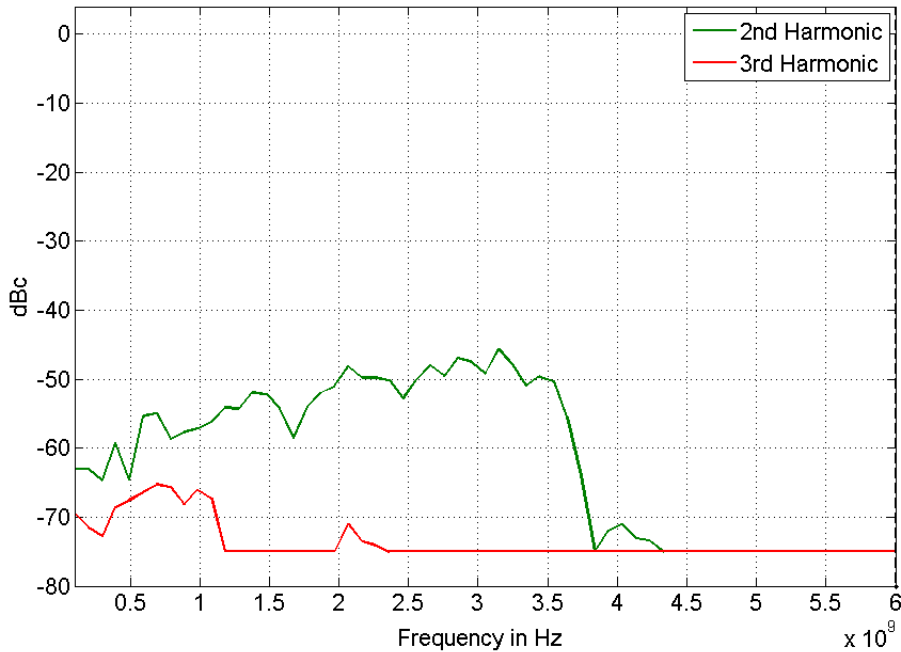
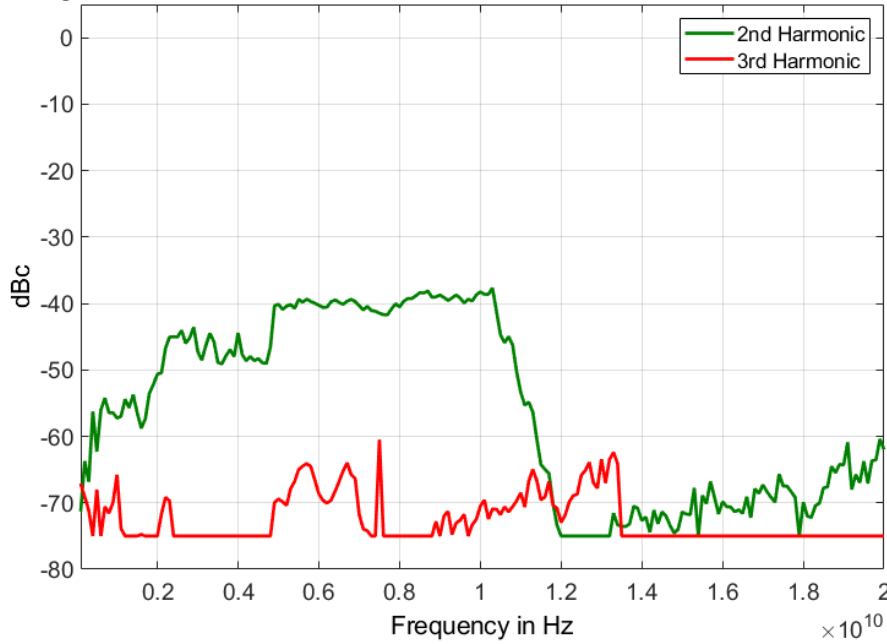

Figure 14: APVSG20 - Harmonic Performance at Pout = 0 dBm



Sweeping Capability

PARAMETER	MIN	TYPICAL	MAX	NOTE
Sweep Type	Digital sweep in discrete steps			
Automatic Level Control (ALC) Mode	OFF			
Power Level Uncertainty		0.5 dB TBD	1 dB TBD	APVSG04 APVSG06/12/20/40
Frequency & Amplitude Switching Transient Time (can be blanked during "Delay Time")		500 μs 1 μs 2 μs		APVSG04 Option UFS APVSG20, APVSG40 Option UFS
Sweep Spacing	Linear			
Sweep Shape	Sawtooth			
Sweep Parameters	Frequency, power			
Sweep Range	Full specified range -20 to +15 dBm			Frequency sweep Power sweep, APVSG04
Step Size Setting Resolution	0.001 Hz 0.01 dB			Frequency sweep Power sweep
Dwell Time Setting Range	500 μs 800 ns TBD		34.35 s 34.35 s 34.35 s	APVSG04 Option UFS APVSG20, APVSG40 Option UFS
Delay (off) Time Setting Range	200 ns 200 ns		34.35 s 34.35 s	APVSG04 APVSG20, APVSG40
Dwell/Delay Time Resolution	8 ns			
Sweep Count	Infinite, 1 to 1 M			
Sweep Trigger				
Trigger Type	Normal (full sweep), Point (one step)			Check with Anapico support
Trigger Parameters	See chapter "Trigger Capability"			
Retrigger Setup Time	200 ns			
External Trigger Event to RF Output Delay	TBD ns typ TBD			APVSG04, Option UFS APVSG20, APVSG40, Option UFS

Phase-Coherent Modes

MODE	DESCRIPTION	REMARKS
Phase coherent switching ² (Multi-channels mode)	Phase coherent switching guarantees deterministic and reproducible phase relationships between multiple individual channels across multiple individual units.	Option PHS
Phase coherent switching ² (Multi-device mode)	The Phase-coherent switching mode also enables synchronous playback of IQ waveforms on multiple channels and multiple devices	Options SYNC+PHS
Phase Memory	With phase memory the RF output phase behave as if switching between individual, continuously running RF sources	Option PHS
Phase calibratable mode	Different combinations of phase correction and phase calibratable mode are available: <ul style="list-style-type: none"> Phase correction off, phase calibratable mode off: This is the default operation mode. Channel-to-channel relative phases are stable and repeatable, but not zero and vary over power and frequency. Phase correction off, phase calibratable mode on: This mode enables linear relative phase variation over frequency and static phase over power. Channel-to-channel relative phases are stable and repeatable, but not zero. Phase correction on, phase calibratable mode on: Correction values are interpolated between points. This enables true zero phase offset between channels over any frequency / power range (up to a device's full power and frequency range). 	Option PCM

Figure 15: Phase-Coherent Switching

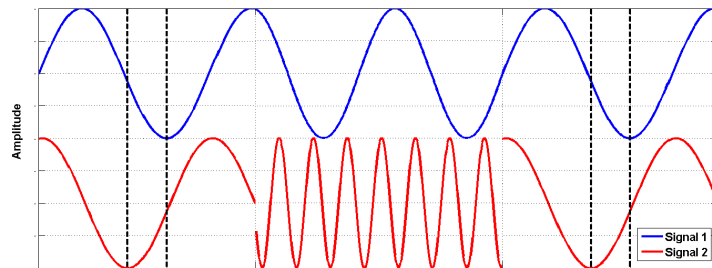

The relative phase between channels 1 and 2 (signal 1 and 2) remains the same after channel 2 temporarily switched to a different frequency. The frequency switching itself is phase discontinuous because the original phase is restored.

Figure 16: Phase Memory

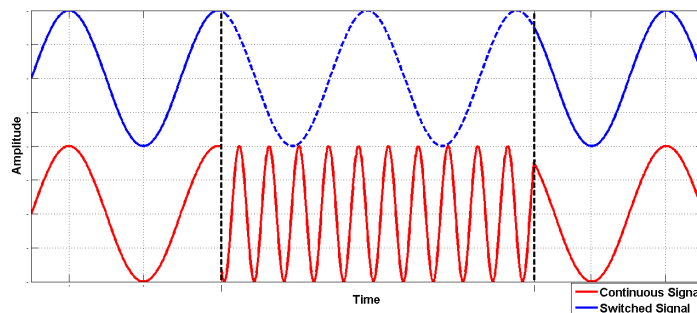

The signal returns to the same absolute phase when returning to the previous frequency and amplitude setting.

² Limitations. As the synthesized signal undergoes further routing and signal conditioning, like filtering and amplitude control, it is subject to electrical delays before reaching the RF output. Those delays vary with RF amplitude and frequency but are otherwise stable. That means that the relative phase between channels will not be zero, but still deterministic and reproducible. For any fixed combination of frequency and amplitude settings, the resulting relative phase between channels will always be the same, even over power cycles.

Multi-Channel Performance

PARAMETER	MIN	TYPICAL	MAX	NOTE
Isolation between Channels		> 90 dB		
Relative Phase Stability		TBD		
Additional Features				
Trigger Source		Synchronous (initiate and trigger multiple channels)		
Additional Delay to Asynchronous Characterizations		1 μ s +/- 100 ns		
Channel to Channel Jitter		+/- 10 ps typ.		

Figure 17: Phase coherence performance at 38 GHz

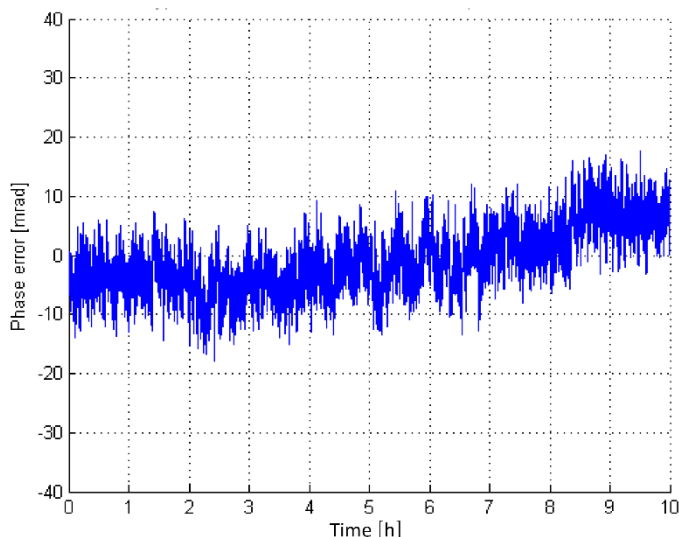
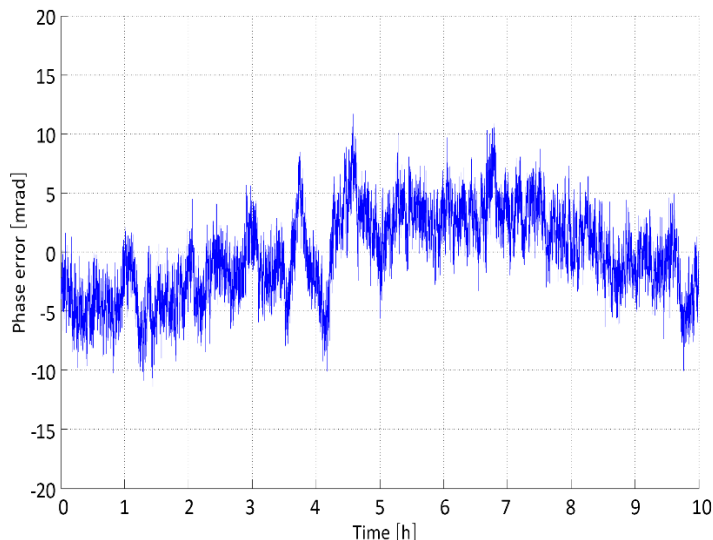

Figure 18: Phase coherence performance at 15 GHz



Multi-Device Performance (Option SYNC)

PARAMETER	MIN	TYPICAL	MAX	NOTE
Multi-Device Synchronization		TBD		
Relative Phase Stability		TBD		

Figure 19: APVSG typical domain channel-to-channel phase error at Ch1 @0.5 GHz mixed with Ch2 @2.5 GHz VS 2 GHz from other device

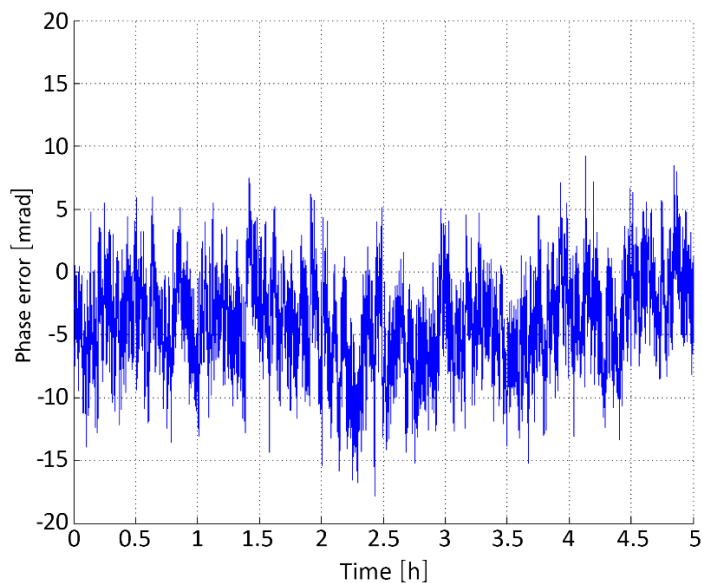
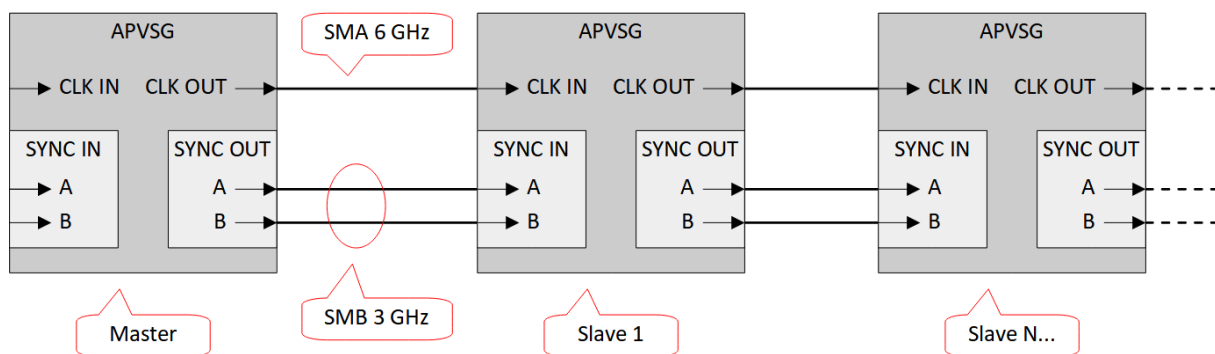

Figure 20: Connections for multi device synchronization: The reference clock uses SMA connectors. Connectors and cable must support at least 6 GHz bandwidth. The synchronization signals A, B, C use SMB connectors. Connectors and cables must support at least 3 GHz bandwidth.



Analog Modulation (Option MOD)

Pulse Modulation

PARAMETER	MIN	TYPICAL	MAX	NOTE
Pulse Modulation				
Modulation Source	Internal pulse generator, external			
Modulator	RF, BB (baseband)			
Pulse Rise/Fall Time		5 ns		10% / 90% of amplitude
On/Off Ratio	90 dB 40 dB tbd dB	95 dB 45 dB tbd dB		BB pulse modulator <4 GHz RF pulse modulator >4 GHz RF pulse modulator
Pulse Overshoot			1 dB	
Video Feedthrough		-70 dB -50 dB		0 dBm, PRF 500 kHz, 50% duty cycle, BB pulse modulator 1 GHz 20 GHz
Polarity / Video Polarity	Normal, inverted			independently selectable
External Pulse Input to Video Output Delay		20ns		
Video Output to RF Output Delay		5ns 400ns		RF modulator BB modulator
External Trigger to Video Output Delay		tbd		
Pulse Jitter		<10 ps +/-8 ns	<1 ps	Internal External, RF pulse modulator External, BB pulse modulator
Internal Pulse Generator				
Pulse Mode	single pulse			
Pulse Period Setting Range	2 * min pulse width setting		10 s	
Pulse Period Setting Resolution	8 ns			
Pulse Width Setting Range	96 ns 8 ns		10 s	Option UFS
Pulse Width Setting Resolution	8 ns			
Pulse Width Accuracy	same as time base			

Figure 21: Pulsed Chirp (10 μ s, 400 MHz Bandwidth)

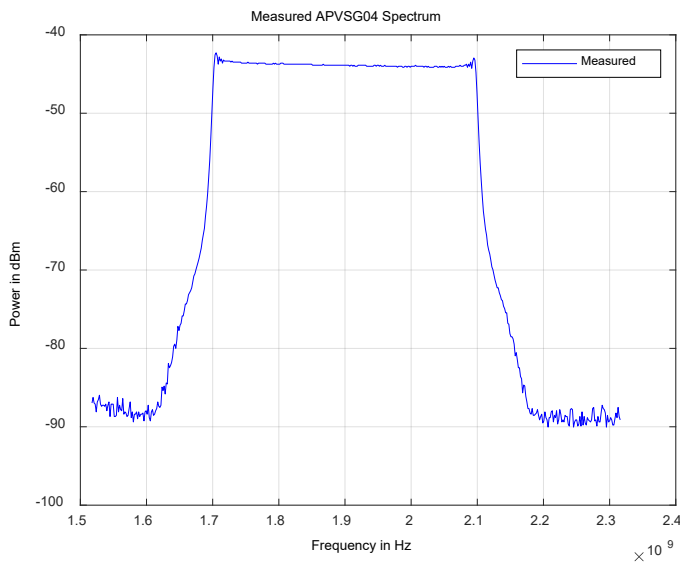

Figure 22: Pulse Modulation (10 MHz Rate, 10 ns Pulse Width)

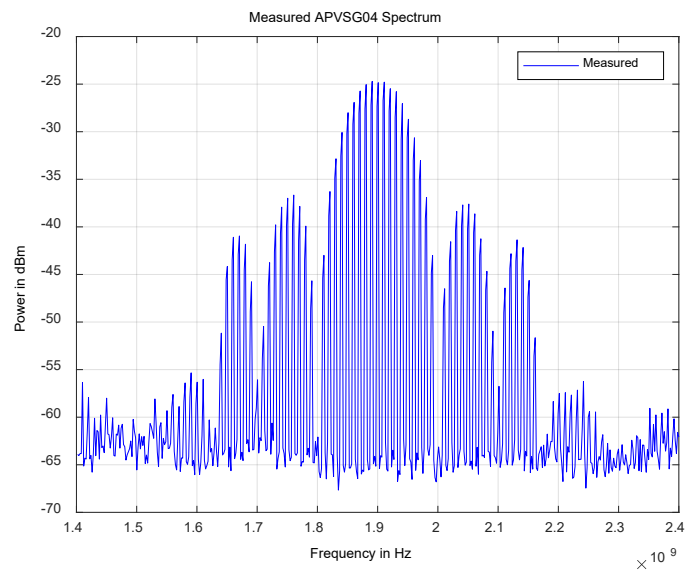

Figure 23: Pulse modulation 16 ns at 10 GHz

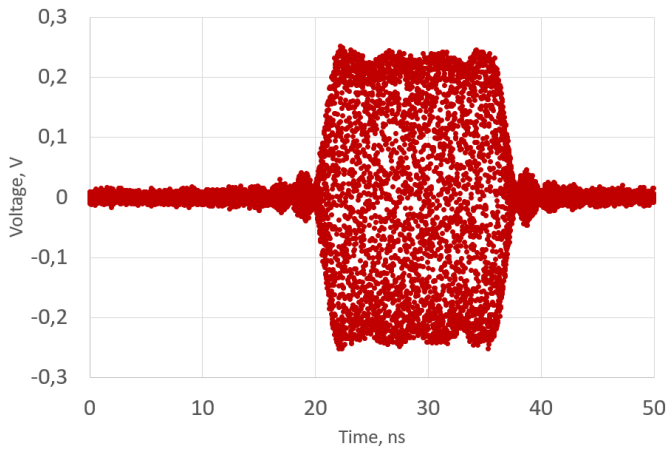
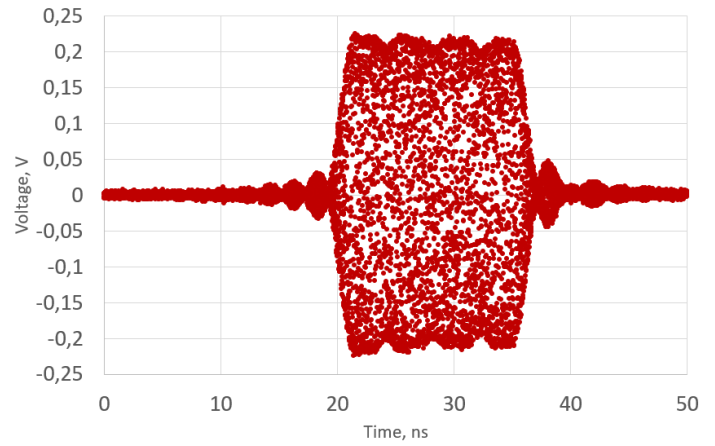

Figure 24: Pulse modulation 16 ns at 40 GHz



Amplitude Modulation

PARAMETER	MIN	TYPICAL	MAX	NOTE
Amplitude Modulation				
Modulation Source		Internal External		Option AIQ
Modulation Depth	0%		99.9%	Output is clipped at max power level
Deviation Accuracy		0.1%	1%	1 kHz rate, 80% depth
Deviation Resolution		0.1%		
Distortion (THD)			1%	1 kHz rate, 80% depth
Modulation Frequency Range	0.1 Hz		100 MHz	
Modulation Waveforms		Sine		

Figure 25: Amplitude Modulation (1 kHz Rate, 80% Depth)

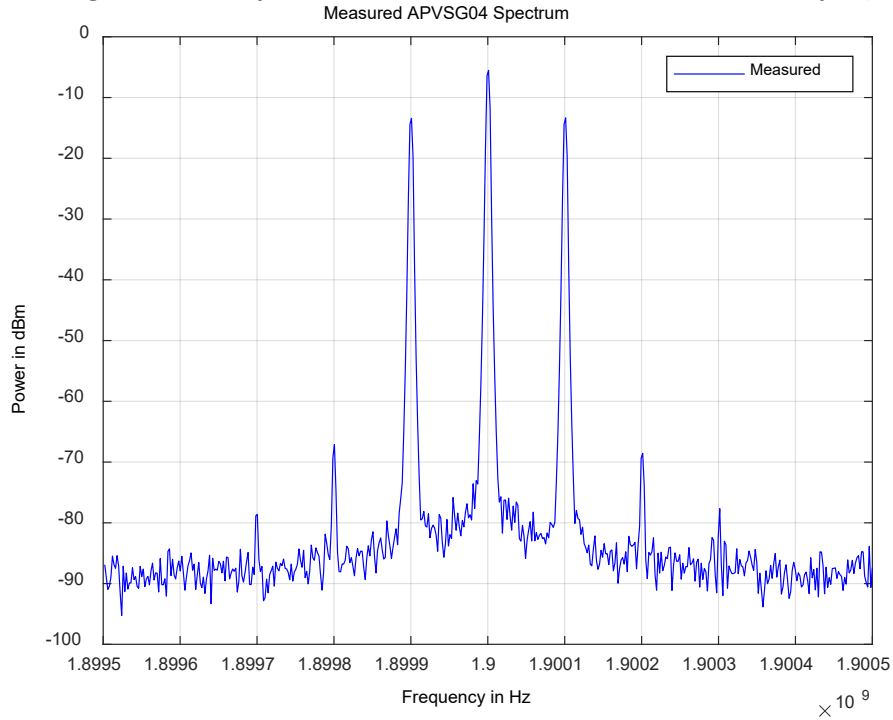

Frequency Modulation

PARAMETER	MIN	TYPICAL	MAX	NOTE
Frequency Modulation				
Modulation Source		Internal External		Option AIQ
Maximum Frequency Deviation (peak)		200 MHz		
Deviation Accuracy		0.5%	1%	
Distortion (THD)		< 1%		1 kHz rate, 10 kHz deviation
Modulation Frequency Range	0.1 Hz		100 MHz	
Modulation Waveforms		Sine		

Figure 26: Wideband FM (1MHz Rate, 200 MHz Deviation)

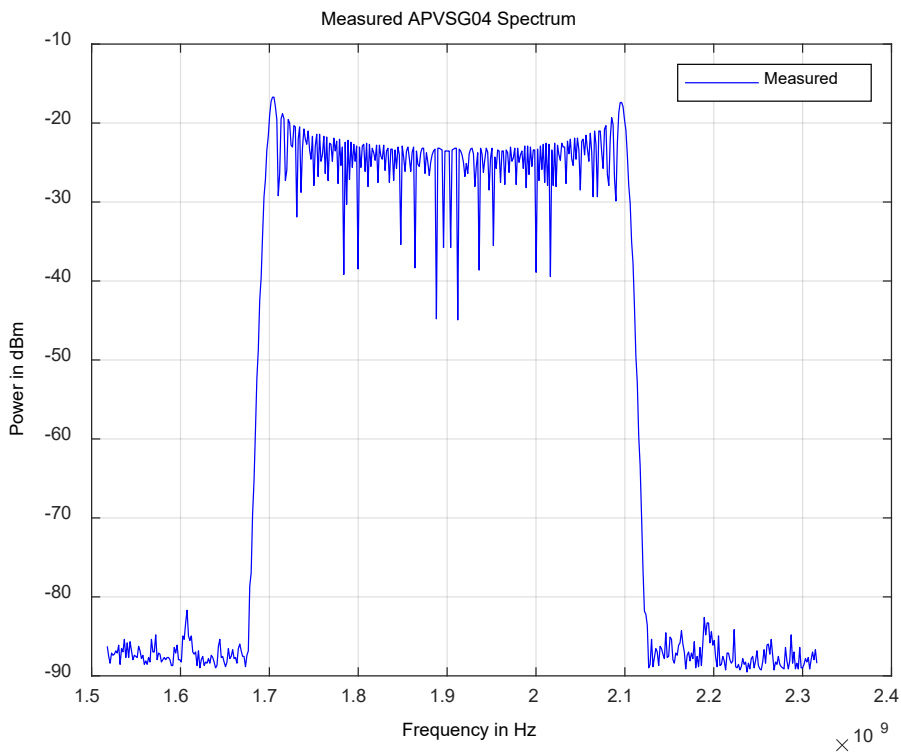

Phase Modulation

PARAMETER	MIN	TYPICAL	MAX	NOTE
Phase Modulation				
Modulation Source		Internal External		Option AIQ
Phase Deviation (peak)	0		100 rad	
Deviation Accuracy		0.5%	1%	
Modulation Frequency Range	0.1 Hz		100 MHz	
Modulation Waveforms		Sine		
Distortion (THD)		< 1%		1 kHz rate & N x rad deviation



Pulse Descriptor Word (Option PDW)

The PDW is an operating mode of the APVSG which takes control of the RF output. Other APVSG features cannot be used simultaneously unless their settings are available as PDW parameters. The PDW feature supports several methods for uploading parameters to the device, including PDW list files in .csv format and streaming through FCP.

PARAMETER	MIN	TYPICAL	MAX	NOTE
PDW Format				
PDW Mode		List Stream		Option FCP
PDW Time Mode		relative, absolute		
Controllable Parameters		start time, pulse width, frequency, power, phase, waveform segment ID		
Parameter Range		Full specified range -20 to +15 dBm 8 ns to 208 d 8 ns to 208 d		RF Frequency / RF Phase RF Power Start Time Pulse Width
Parameter Setting Resolution		$1/2^9$ Hz $1/2^7$ dB 0.0055 deg 8 ns		RF Frequency RF Power RF Phase Start Time / Pulse Width
Automatic Level Control (ALC) Mode		OFF		
Power Level Uncertainty		0.5 dB <i>TBD</i>	1 dB <i>TBD</i>	APVSG04 APVSG20, APVSG40
PDW Timing				
Switching Time (Transient)		500 μ s <i>TBD</i> ($\approx 20 \mu$ s) 2 μ s 3.2 μ s		APVSG06/12/20/40 Option UFS APVSG04 Option UFS & Option PHS APVSG04 Option UFS
Pulse Width	32 ns 8 ns			Option UFS
Play Time			208d	Absolute Time Mode
Simulation Trigger Setup Time		32 ns		
Trigger Parameters	See chapter "Trigger Capability"			
PDW Buffer Size	1 PDW		1024 PDW	for both PDW Modes
PDW List Count	Infinite, 1 to 65 M			

Mode Overview

PDW Mode	Input Interface	PDW upload	Device Storage	Simulation
List	APVSG GUI/ SCPI commands	before Simulation starts	PDW Memory	All PDWs in List, optionally repeat List
Stream	FCP / SCPI commands	before and during Simulation	PDW Buffer (FIFO)	PDWs in order of upload, only once.

PARAMETER	MIN	TYPICAL	MAX	NOTE
RF modulation bandwidth		400 MHz		
I/Q Frequency Response over full 400 MHz I/Q Bandwidth		±1.0 dB ±1.5 dB ±2.0 dB	±1.5 dB ±2.5 dB ±3.5 dB	< 6 GHz 6 to 20 GHz 20 to 40 GHz
Carrier Leakage		-90 dBc	-70 dBc	
Image Sideband Rejection	65 dBc	85 dBc		

Figure 27: I/Q Relative Response (measured) APVSG04

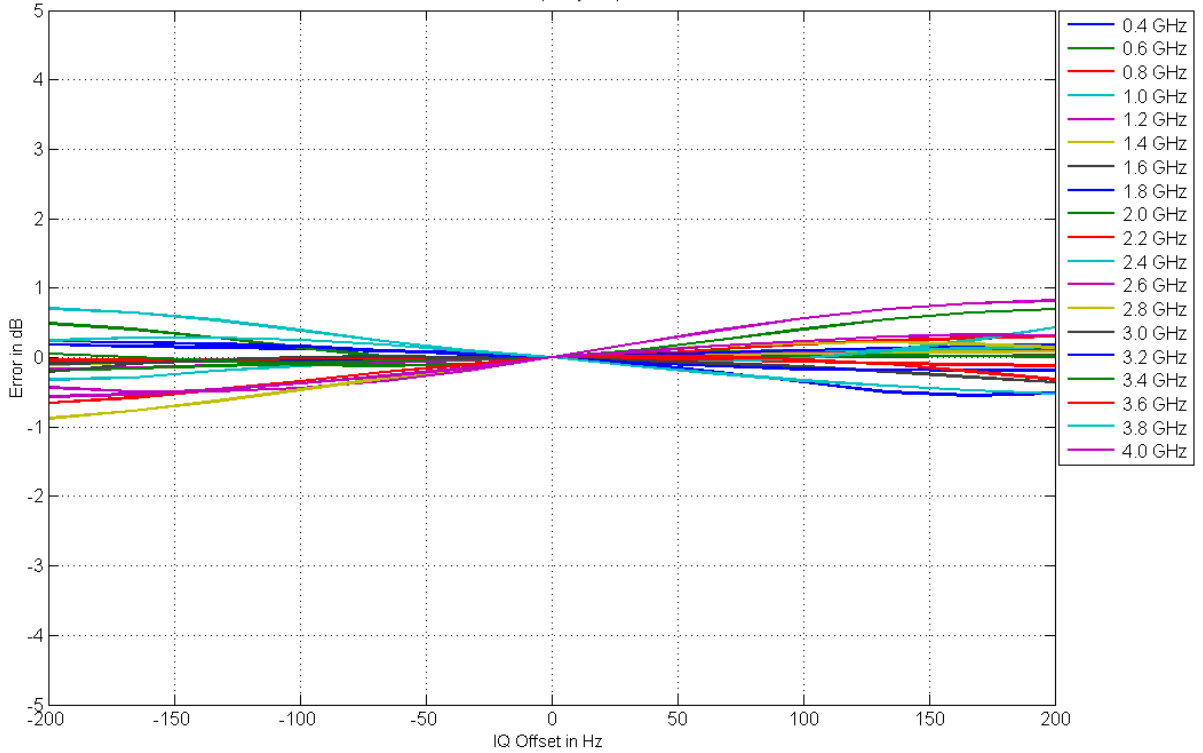

Figure 28: I/Q Relative Response (measured) APVSG20

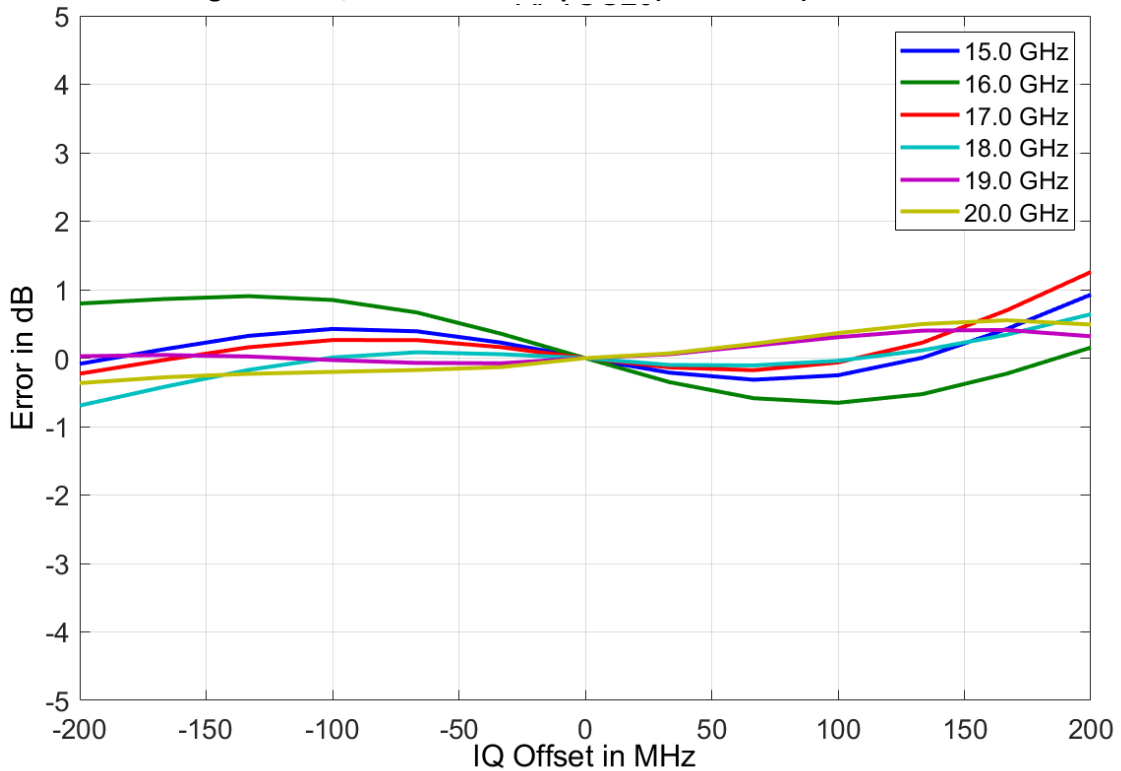
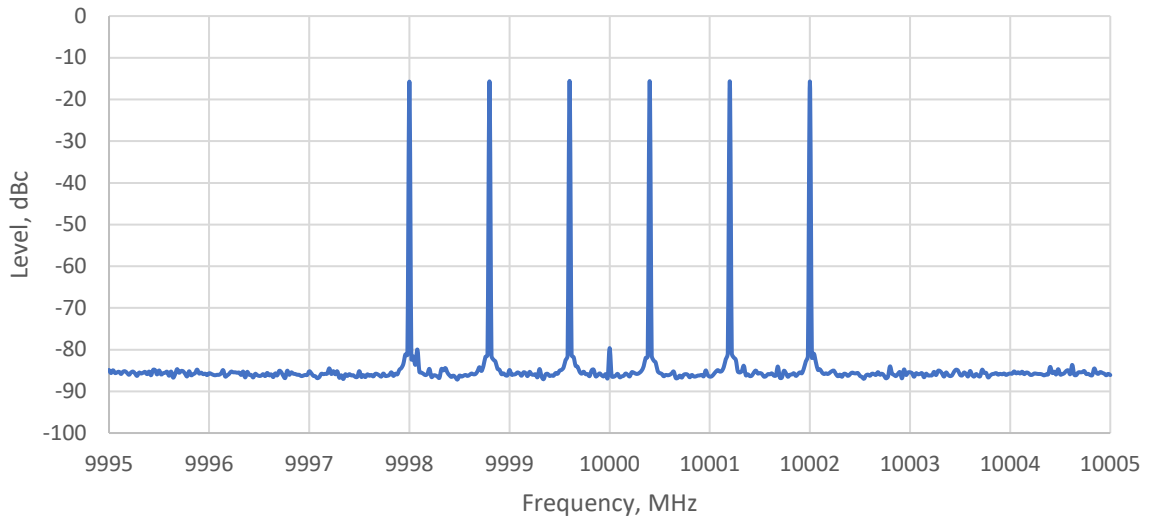

Figure 29: Carrier suppression -80 dBc for 0 dBm 6-tone signal at 10 GHz carrier



Internal I/Q Baseband Generator

PARAMETER	MIN	TYPICAL	MAX	NOTE
Sample Resolution	16 bits			each I and Q
Clock Source	Internal			
Sample Rate	10 Hz		500 MHz	
Sample Rate Resolution	1 Hz			
Waveform length, Number of Samples	96 * 246 *		512 M 334 M	Marker signals active
Segment Mode				
Number of Segments	1		65k	
Segment Changeover	Seamless, immediate			
Trigger Modes	Same segment, next segment, addressed segment			
Sequencer Play List Length	1		2048	
Sequence Segment Repetitions	1		10 M	
Changeover Time		2 μ s		500 MHz sample rate, after trigger event received, immediate segment changeover
Arbitrary Trigger				
Trigger Type	Normal, Next segment, next sequence			Check with Anapico support
Trigger Parameters	See chapter "Trigger Capability"			
External Trigger Event to RF Output Delay	0.5 μ s +/-100 ns			500 MHz sample rate
Marker Signals				
Markers are defined during the waveform generation process.				
Number of Markers		4		
Type	Waveform			
Marker Delay Setting Range		tbd		
Marker Delay Setting Resolution		tbd		
Marker Duration Minimum Value		1 sample 4 samples		Sample rate \leq 125 MHz Sample rate $>$ 125 MHz
Marker Duration Variation			+/- 1 sample +/- 8 ns	Sample rate $<$ 125 MHz Sample rate \geq 125 MHz
Marker Jitter			+/- 1 sample +/- 8 ns	Sample rate $<$ 125 MHz Sample rate \geq 125 MHz
Marker Polarity	Normal, inverted			
Marker Output to RF Output Delay		tbd		

* Shorter Waveforms will be automatically extended by cyclically repeating the waveform.

Internal Vector Modulation (Option IVM)

PARAMETER	MIN	TYPICAL	MAX	NOTE
Modulation Schemes	8QAM, 16QAM, 32QAM, 64QAM, 128QAM, 256QAM, 512QAM, 1024QAM, 2048QAM, 4096QAM			
Symbol Rate	10 S/s		200 MS/s	
Filter Type	cosine, root cosine, gaussian, rectangular, dirac, rectangular asymmetric			
Filter Parameter Range	0.05 0.05		1 2.5	Cosine, Root Cosine (Parameter α) Gaussian (Parameter B \times T)
Data Source	PRBS generator, user data list, external real-time data			Optional, check with Anapico support
Data Lists	8 bits		256 Mbits	Optional, check with Anapico support

Figure 30: 256QAM 10 MS/s

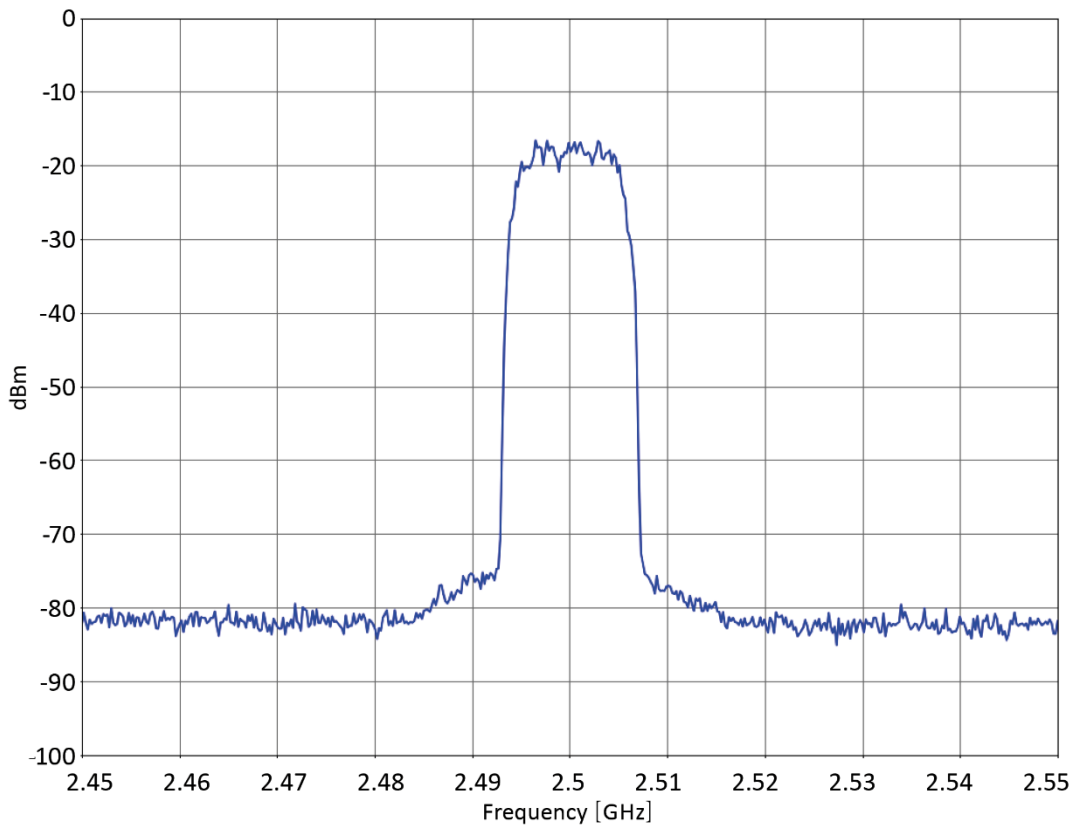

Figure 31: 16QAM 250 MS/s

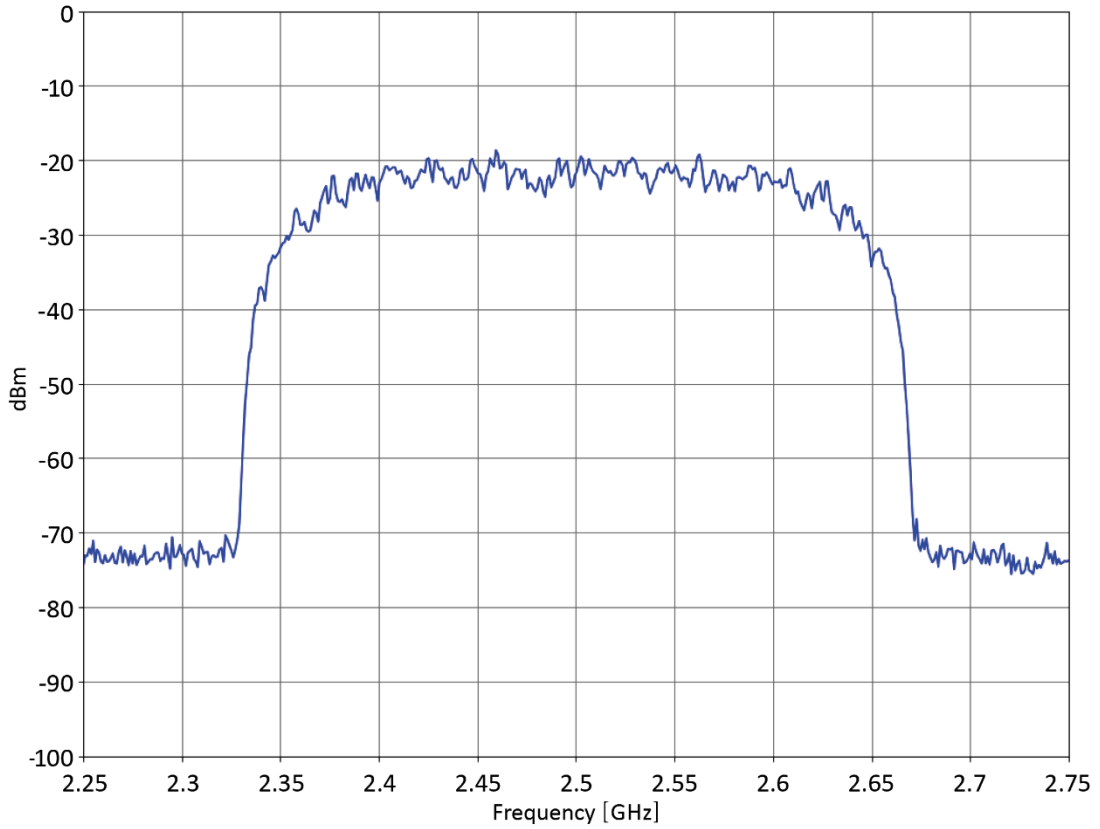

Figure 32: EMV vs Output Power, 16QAM, 10 MS/s, 2.5 GHz

16QAM, 2.5 GHz, 10 MSym/s

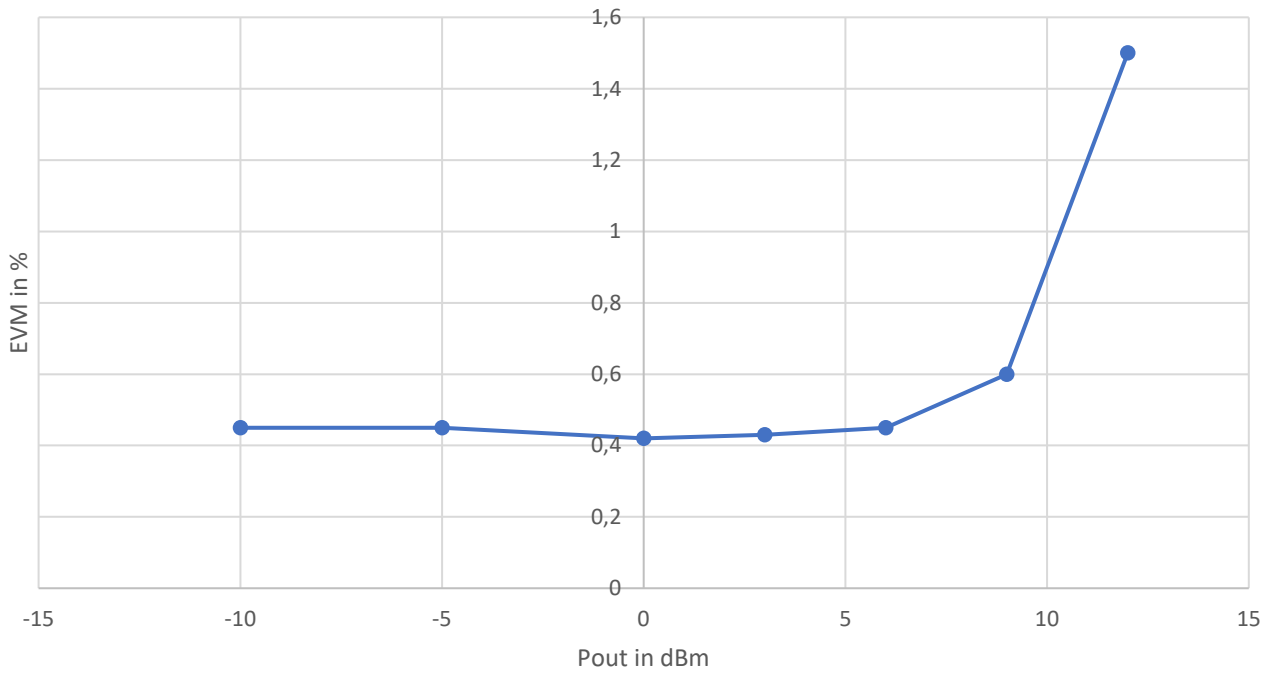

Figure 33: EMV vs Symbol Rate, 16QAM

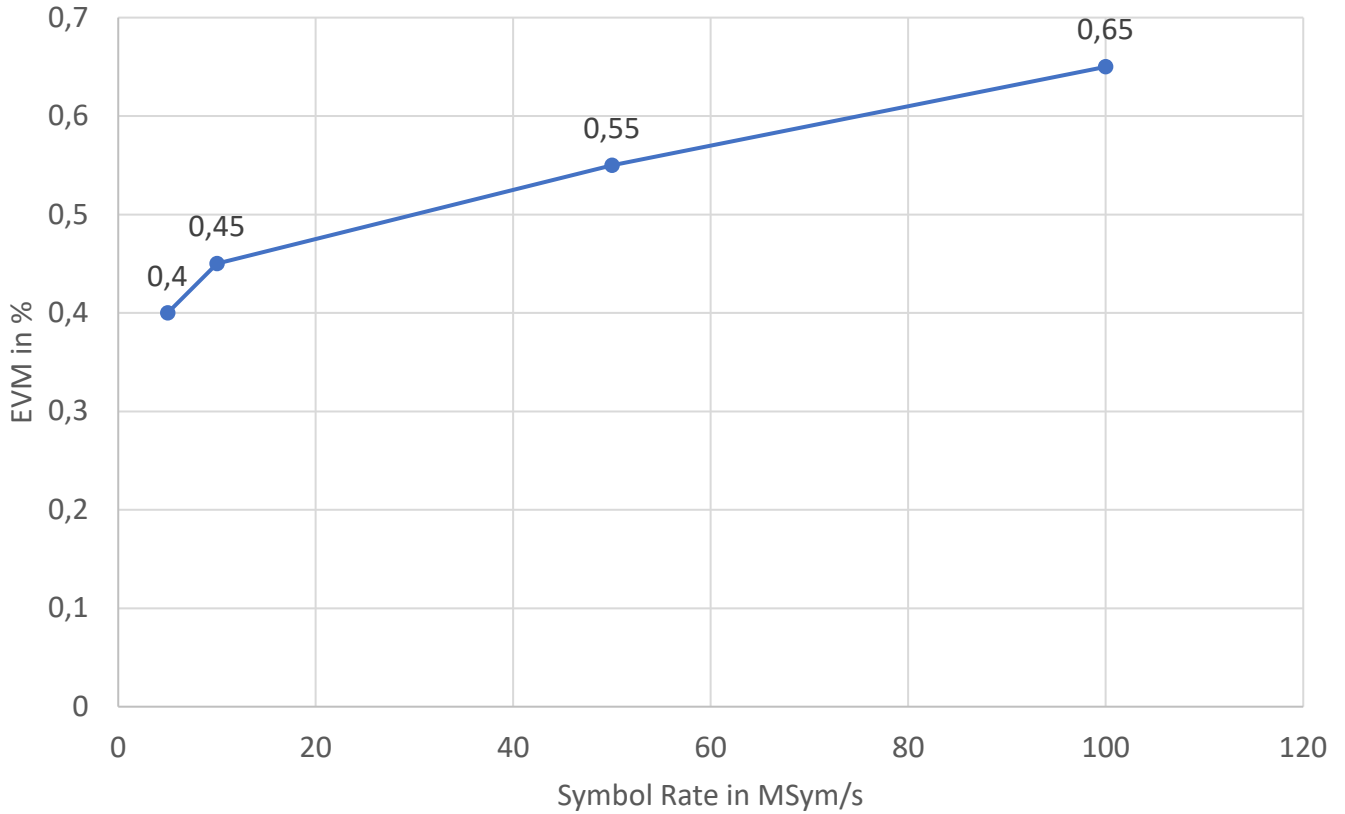
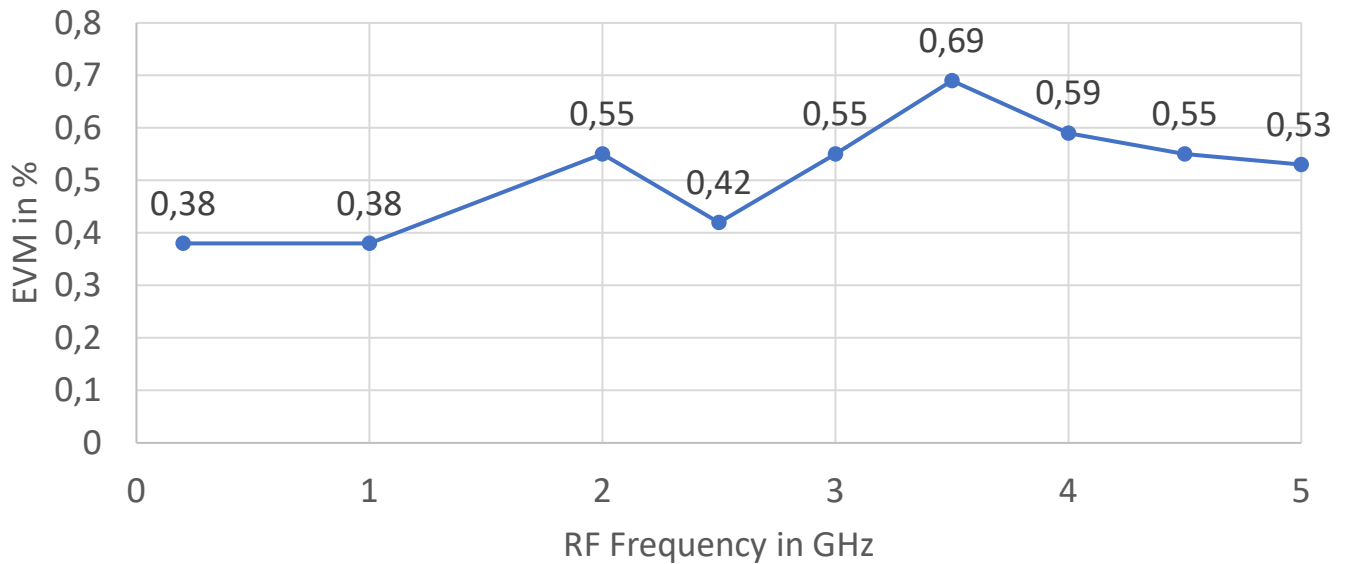

Figure 34: EMV vs RF Frequency, 16QAM, 10 Msymbols/s

16QAM, 10 MSymb/s



Multicarrier Generation (Option IVM)

PARAMETER	MIN	TYPICAL	MAX	NOTE
Number of Carriers	1		1 k	
Frequency Offset	-200 MHz		200 MHz	
Power Offset	-60 dB		0 dB	0.1 dB resolution
Tone Initial Phase Offset	0 deg		360 deg	0.1 deg resolution

Figure 35: 64-tone 400 MHz Bandwidth Signal

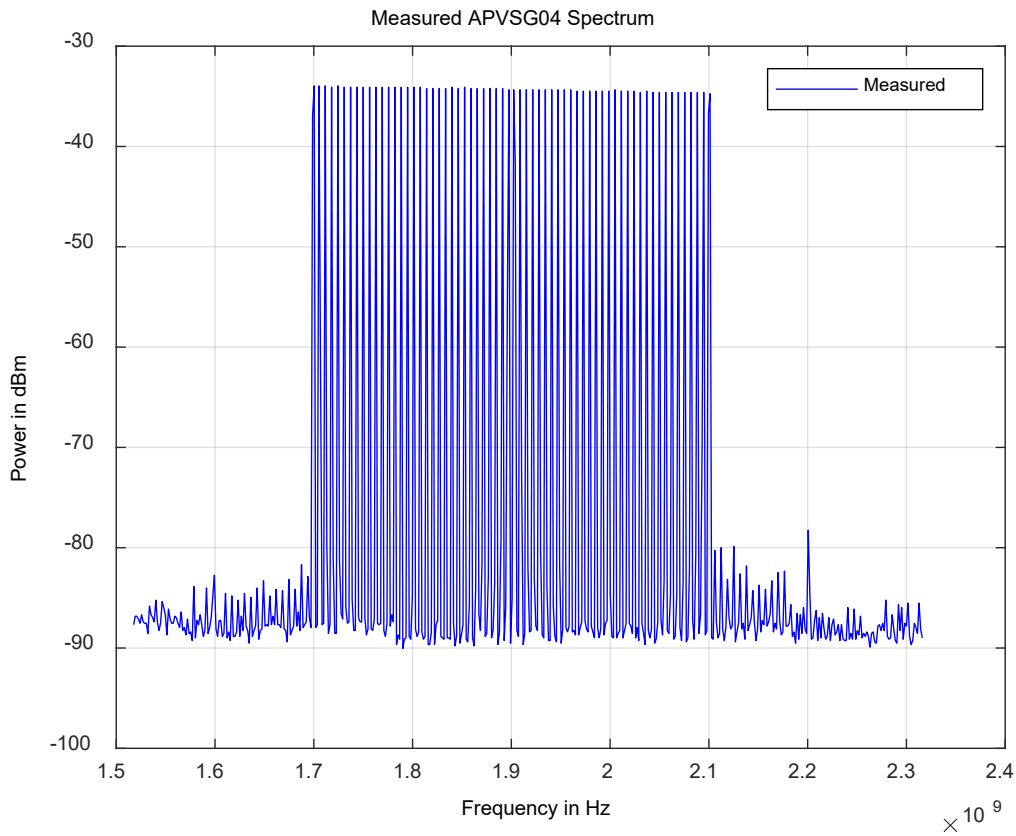
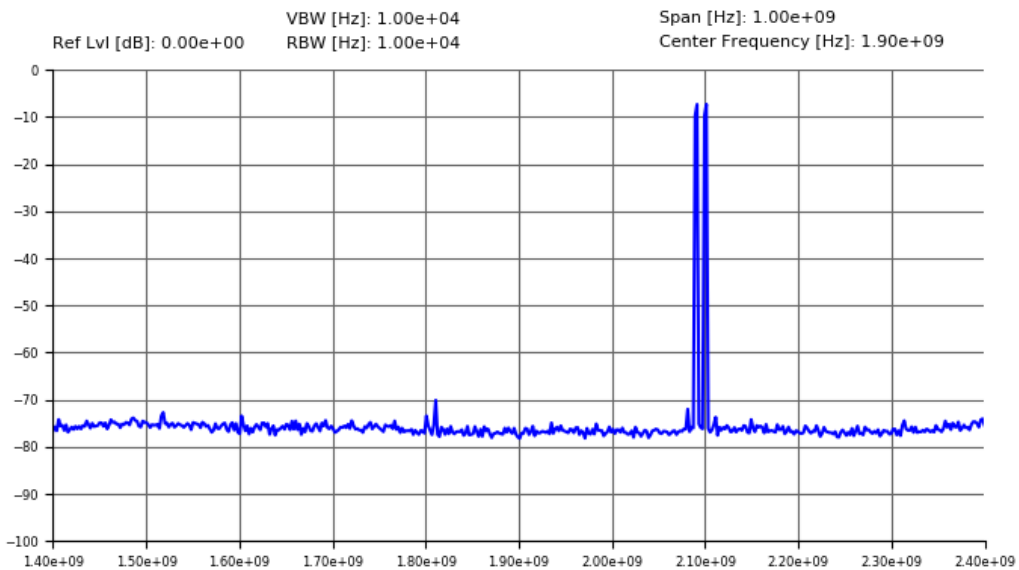

Figure 36: Two-tone Sideband Rejection



Avionics Modulation (Option AVIO)

PARAMETER	MIN	TYPICAL	MAX	NOTE
AVIO Modulation DME				
Operating Modes	interrogation & reply			
DME Channel	X, Y			
Frequency Range	960 MHz		1215 MHz	
Pulse On/Off ratio		80 dB	70 dB	
Pulse Rise/Fall times	100 ns		50 μ s	100 ns resolution
Pulse Width	100 ns		50 μ s	100 ns resolution
Pulse Spacing	100 ns		300 μ s	100 ns resolution
Pulse Rate	10 Hz		10 kHz	1 Hz resolution

Pulse Shaping	cos, cos ² , cos/cos ² , linear, gauss			individually settable for rising & falling edge
AVIO Modulation VOR	108 MHz		118 MHz	
Bearing Accuracy	±2% / ±0.5 deg			
Subcarrier Frequency Accuracy	9960 ± 2 Hz			
AM Accuracy	30 ± 1%			
AM Distortion (THD)			2%	
FM Accuracy	480 ± 1 Hz			
IDENT AM depth	10 %		30 %	
AVIO Modulation ILS	108 MHz		112 MHz	
AM Accuracy	40 ± 1%			
AM Distortion			0.5%	
DDM Resolution		0.0002 0.0004		Localizer Glide Slope
DDM Accuracy		0.0004 0.0008		Localizer Glide Slope
Marker Beacon				
AM Tone Accuracy (95% AM)		5% of setting		
AM Tone Distortion (95% AM)		5%		

Figure 37: DME Spectrum (X Channel, Raised Cosine Filter)

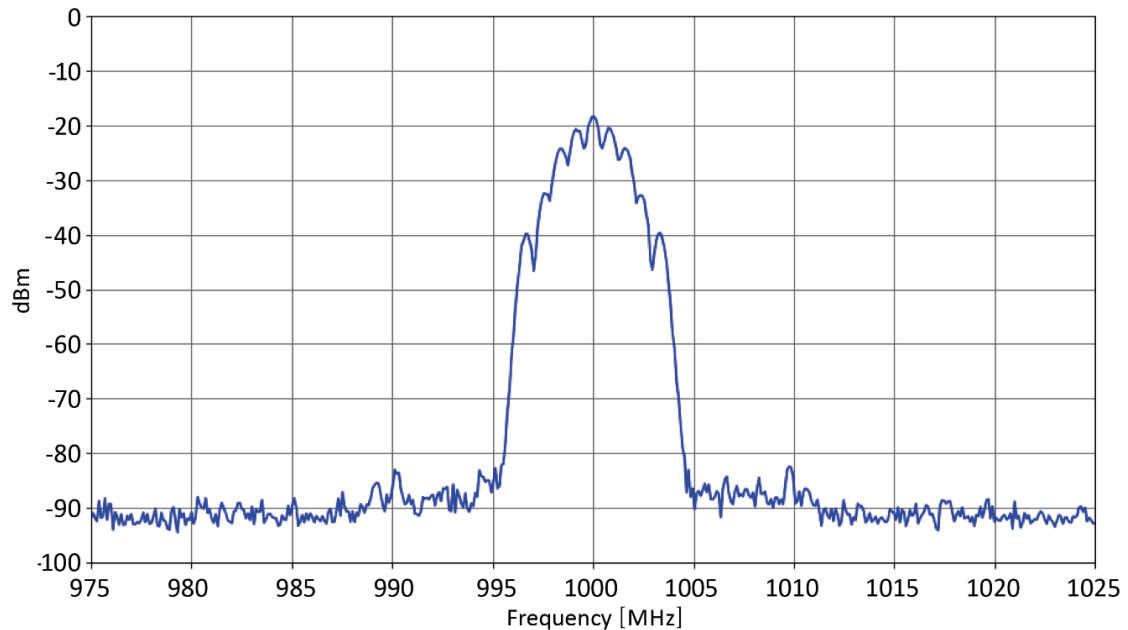

Additive White Gaussian Noise (Option AWGN)

PARAMETER	MIN	TYPICAL	MAX	NOTE
Noise				
Distribution Density	Gaussian, statistical, $\mu = 0, \sigma^2 = 1$			Separate for I and Q
Crest Factor	≤ 21.07 dB			Depending on C/N ratio
Periodicity	> 7×10 ⁴⁴ s			
Carrier to Noise Ratio C/N				
Range	-60 dB		90 dB	Limited by the RF output power
Resolution		0.01 dB		See application note "AN6005"
Noise Bandwidth				
Dependency	0.8 of I/Q baseband generator sample rate Manually			Any modulation active All modulations inactive
Range	10 Hz		400 MHz	
Resolution	1 Hz			
Power Control Mode	Total, carrier, noise			

Trigger Capability

PARAMETER	MIN	TYPICAL	MAX	NOTE
Trigger Mode	Single, continuous			
Trigger Source	Internal (Immediate, bus), external			
External Trigger Input				
Connector Type	MF1 IN, MF2 IN			see chapter "External Multi-Function Inputs"
Delay Setting Range	0 s		8.5 s	
Delay Setting Resolution		2 ns		
Jitter		+/-2 ns		
Slope	Rising, falling			
Trigger Output				
Connector Type	MF1 OUT, MF2 OUT			see chapter "External Multi-Function Outputs"
Polarity	Normal, inverted			
Delay Setting Range	0 s		2 μ s	
Delay Setting Resolution		2 ns		
Pulse Width Setting Range	8 ns		16 μ s	
Pulse Width Setting Resolution		8 ns		

External Multi-Function Inputs

PARAMETER	MIN	TYPICAL	MAX	NOTE
Connector	MF1 IN, MF2 IN			see chapter "CONNECTORS"
Application	External pulse modulation, external trigger			
Nominal Input Impedance	DC 10k Ω and AC 50 Ω			
Threshold Voltage	0.85V	0.9 V	0.95 V	
Nominal Input Voltage	0 V		3.3 V	TTL compatible
Hysteresis		60 mV		

External Multi-Function Outputs

PARAMETER	MIN	TYPICAL	MAX	NOTE
Connector	MF1 OUT, MF2 OUT			see chapter "CONNECTORS"
Application	Pulse video signal, trigger, marker signals (1-4)			
Nominal Output Impedance	tbd			
Nominal Output Voltage	0 V		3.3 V	LVTTTL

Fast Control Port (Option FCP)

PARAMETER	MIN	TYPICAL	MAX	NOTE
Interface	Parallel, bidirectional LVDS with 100 Ω termination at receiver			
Common Mode Level				typ. 1.2V
Differential Input Threshold				typ. +/-100mV
Differential Output Voltage				typ. 300mV
Connector	FCP I/O - see chapter "CONNECTORS"			
Mode: I/Q Data Streaming				
Sample Rate ()				125 and 250 MHz
Input/Output Format				data (16 bits), clock signal, valid signal
Valid I/Q Data Input to RF Output Delay				typ. tbd ns
Mode: Segment ID Streaming				
Input Format				data (16 bits), valid signal (signal must be static low or high)
Valid Segment ID Input to RF Output Delay (immediate segment changeover)				typ. tbd ns
Valid Segment ID Jitter				+/- 8 ns
Mode: CDW Streaming	APVSG04 Option FCP & UFS			
	CDW is an operating mode of the APVSG which takes control of the RF output. Other APVSG features cannot be used simultaneously unless their settings are available as CDW parameters.			

Parameter	Frequency (up to 48bit), power, phase, segment ID
Parameter Range and Resolution	see chapter "PDW"
Input Format	address (8 bits), data (8 bits), valid signal
Sampling Rate	250 MHz
Valid signal level min. period	8 ns
Data to valid setup and hold time	4 ns
Automatic Level Control (ALC) Mode	OFF

Pin assignment	Pin (P/N)	Signal	Pin (P/N)	Signal	Pin (P/N)	Signal
	1/19	data bit 0	2/20	data bit 1	3/21	data bit 2
	4/22	data bit 3	5/23	data bit 4	6/24	data bit 5
	7/25	data bit 6	8/26	data bit 7	9/27	data bit 8
	10/28	data bit 9	11/29	data bit 10	12/30	data bit 11
	13/31	data bit 12	14/32	data bit 13	15/33	data bit 14
	16/34	data bit 15	17/35	valid	18/36	clock

External Analog Inputs (Option AIQ)

PARAMETER	MIN	TYPICAL	MAX	NOTE
Connector		I IN, Q IN		see chapter "CONNECTORS"
Analog Bandwidth		50 MHz		
Maximum Input Voltage	-2 V		+ 2 V	
Nominal Input Voltage Range		+/- 0.5 V		90% full scale
Input Impedance		50 Ω		
Additional Features	Individual gain and DC offset adjustment, overrange detection			
Application	Analog I/Q data modulation external AM, FM, PM modulation		Option AIQ Option AIQ & MOD	

SD Card (Option SD)

PARAMETER	
Supported SD	up to 2 GB with FAT 12 or FAT 16
Supported SDHC	up to 32 GB with FAT 32

Figure 38: User Interface

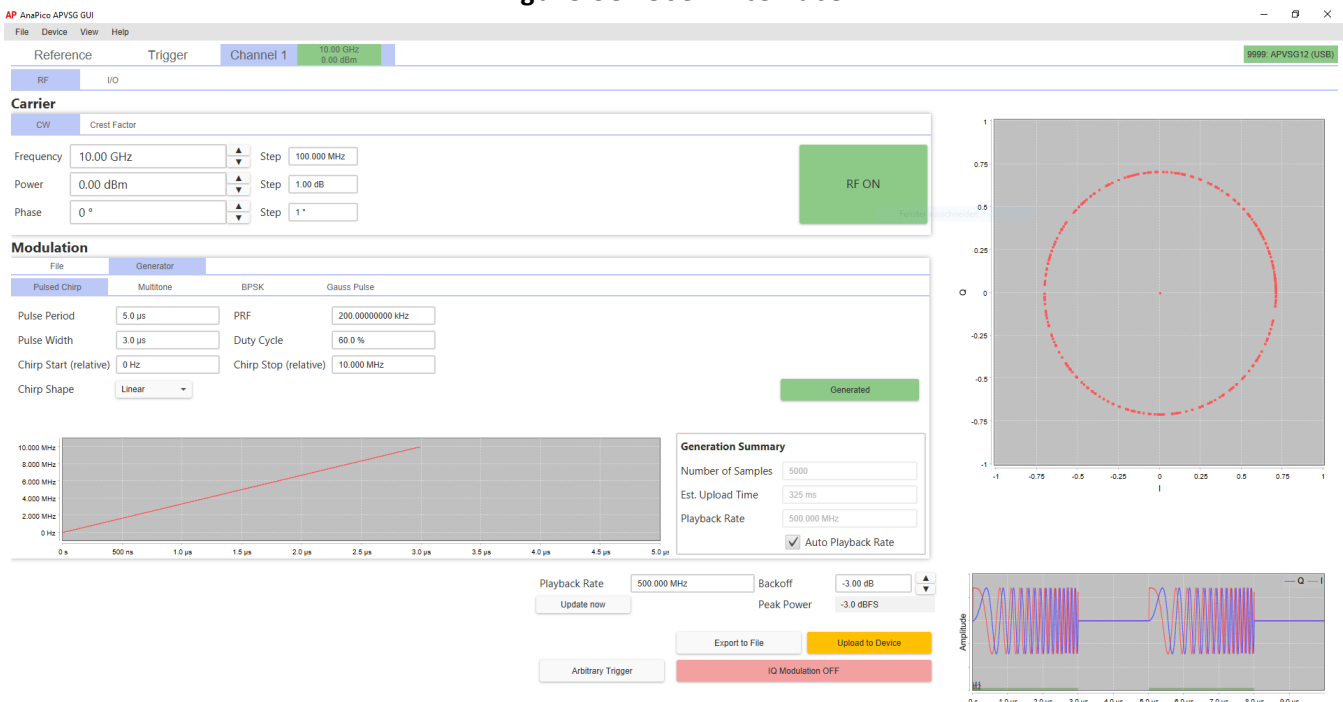

CONNECTORS

Front Panel (Single Channel Model):

LABEL	TYPE	DESCRIPTION	OPTION
RF 50 Ω	N female (APVSG04/APVSG06/APVSG12) SMA female (APVSG20) K (2.92mm) female (APVSG40)	RF output	



Rear Panel (Single Channel Model):

LABEL	TYPE	DESCRIPTION	OPTION
DC24V	DC power plug female	Power of instrument	
	M4	Ground reference screw	
USB	USB type B	Remote programming interface	
LAN	RJ-45	Remote programming interface	
CLK IN	SMA, female	High-stability reference input	SYNC
CLK OUT	SMA, female	High-stability reference output	SYNC
SYNC IN, SYNC OUT	SMB, male	Multi-device synchronization ports	SYNC
SD	MicroSD	Card slot for non-volatile storage of I/Q data	
REF IN	BNC female	Reference frequency input	
REF OUT	BNC female	Reference frequency output	
MF1 IN, MF2 IN	SMB male	Multi-function digital inputs: User-configurable	
MF1 OUT, MF2 OUT	SMB male	Multi-function digital outputs: User-configurable	
I IN, Q IN	BNC female	Analog inputs: User-configurable	AIQ
FCP	36-pin mini-D female 3M MDR 102 Series	Fast control port, external digital I/Q data streaming (per channel)	FCP

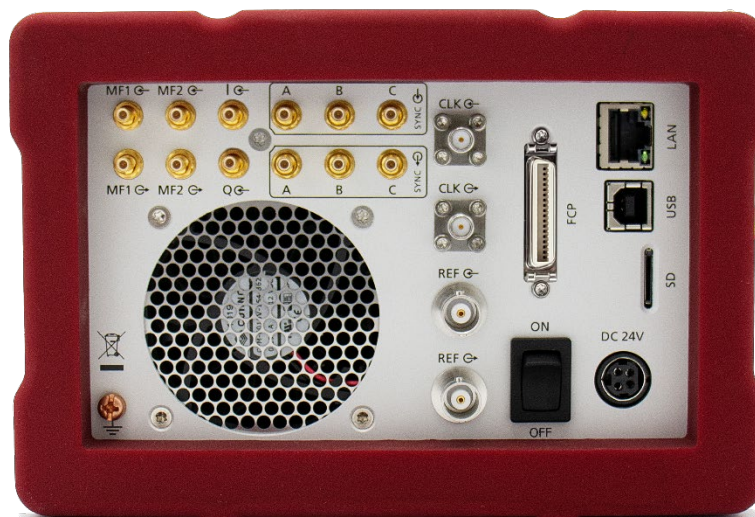



Front Panel (2U Multi-Channel Model):

LABEL	TYPE	DESCRIPTION	OPTION
RF OUT (for each channel)	SMA female / K (2.92mm) female (APVSG40-X)	RF output	



Rear Panel (2U Multi-Channel Model):

LABEL	TYPE	DESCRIPTION	OPTION
-	C13	Power of instrument	
⏏	M4	Ground reference screw (earth)	
USB	USB type B	Remote programming interface	
LAN	RJ-45	Remote programming interface	
GPIB	24-pin female	Remote programming interface	GPIB
SD	MicroSD	Card slot for non-volatile storage of I/Q data	
REF IN	BNC female	Reference frequency input	
REF OUT	BNC female	Reference frequency output	
CLK IN	SMA female	High-stability reference input	SYNC
CLK OUT	SMA female	High-stability reference output	SYNC
FCP (for each channel)	36-pin mini-D female 3M MDR 102 Series	Fast control port	FCP
MF1 IN, MF2 IN (for each channel)	SMB male	Multi-function inputs: User-configurable	
MF1 OUT, MF2 OUT (for each channel)	SMB male	Multi-function outputs: User-configurable	
I IN, Q IN (for each channel)	SMB male	Analog inputs: User-configurable	AIQ
SYNC IN, SYNC OUT	SMB, male	Multi-device synchronization ports (not visible in rear view)	SYNC

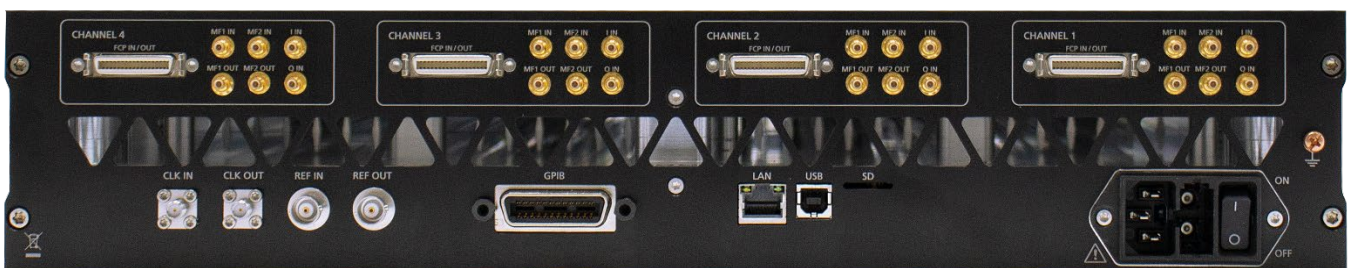

ORDERING INFORMATION

HOST MODEL	PRODUCT	DESCRIPTION
APVSG Single channel model	APVSG04	4 GHz model
	APVSG06	6 GHz model
	APVSG12	12 GHz model
	APVSG20	20 GHz model
	APVSG40	40 GHz model
APVSG-X 2U rack-mount model	APVSG04-X	4 GHz model
	APVSG06-X	6 GHz model
	APVSG12-X	12 GHz model
	APVSG20-X	20 GHz model
	APVSG40-X	40 GHz model

-X: channels = (1),2,3 or 4 channels

HARDWARE OPTIONS	PRODUCT	DESCRIPTION
APVSG(-X)	Option LN	Enhanced close-in phase noise & frequency stability
APVSG(-X)	Option LN+	Enhanced close in phase noise & further enhanced long term frequency stability
APVSG(-X)	Option SYNC	Multi device synchronization ports
APVSG(-X)	Option FCP	Fast control port, external digital I/Q data streaming (per channel)
APVSG(-X)	Option AIQ	External analog I/Q inputs (per channel)
APVSG	Option GPIB	GPIB interface
APVSG(-X)	Option 100K	Frequency range extension to 100 kHz
APVSG04(-X) APVSG06/12/20(-X) APVSG40(-X)	Option PE4-04 Option PE4-20 Option PE4-40	Electronic step attenuator
APVSG04/06/12/20(-X) APVSG40(-X)	Option PE-20 Option PE-40	Mechanical step attenuator (down to -90 dBm)
APVSG04/06/12/20(-X) APVSG40(-X)	Option PE2-20 Option PE2-40	Mechanical step attenuator (down to -120 dBm)
APVSG06/12/20(-X)	Option FILT-20	Harmonic filtering (per channel), option PE4-XX required
APVSG40(-X)	Option FILT-40	Harmonic filtering (per channel), option PE4-XX required

SOFTWARE LICENSES	PRODUCT	DESCRIPTION
APVSG(-X)	Option UFS	Ultra-fast switching speed
APVSG(-X)	Option PHS	Phase-coherent switching
APVSG-X	Option PCM	Firmware for "Phase Calibratable Mode" (per channel), option PHS required
APVSG(-X)	Option PDW	Pulse descriptor word (per channel)
APVSG(-X)	Option MOD	Internal analog modulations
APVSG(-X)	Option IVM	Internal digital modulation schemes (per channel)
APVSG(-X)	Option AVIO	Internal avionic modulations (per channel)
APVSG(-X)	Option AWGN	Additive white gaussian noise generator (per channel)
APVSG(-X)	Option SD	MicroSD card support for non-volatile storage of I/Q data
APVSG(-X)	Option VREF	Variable external reference

ACCESSORIES	PRODUCT	DESCRIPTION
APVSG	Option EB	External power bank adapter cable
APVSG	Option BAG	Portable bag

SERVICE	PRODUCT	DESCRIPTION
APVSG(-X)	Option WE	One year warranty extension
APVSG(-X)	Option ReCal	Recalibration with certificate (recommended: 2 years interval)

GENERAL CHARACTERISTICS

Remote Programming Interfaces

- Ethernet 100BaseT LAN Interface,
- USB 2.0 Device Interface
- GPIB (IEEE-488.2,1987) with listen and talk (Option GPIB)
- Control Language: SCPI Version 1999.0

Power Requirements

Single Channel Model

Input Voltage Range	24 VDC \pm 3.0 V	
Power Consumption (typ) (without Options)	45W 65W	APVSG04 APVSG06 to APVSG40
Main Adapter supplied (without Options)	100 - 240 VAC 50/60Hz; 24 VDC and 65W max	APVSG04
	100 - 240 VAC 50/60Hz; 24 VDC and 160 W max	APVSG06 to APVSG40

Multi-Channel Model

Input Voltage Range	100 - 240 VAC 50/60Hz	
Fuse Rating	5x20mm, 250 V, 6.3 AT	2-poles, each
Power Consumption (max)	200 W 400 W	APVSG4-x, APVSG6-2, APVSG12-2, APVSG20-2, APVSG40-2 APVSG6-4, APVSG12-4, APVSG20-4, APVSG40-4

Environmental (Levels similar to MIL-PRF-28800F Class 3/4)

Environmental stress Samples of this product have been type tested to be robust against the environmental stresses of storage, transportation, and end-use; those stresses to temperature, humidity, shock, vibration, altitude, and power line conditions.

Operating temperature range: 0 to 45 °C

Storage temperature range: -40 to 70 °C

Operating and storage altitude up to 15,000 feet (4600 m)

CE notice

EMC complies to EMC regulations and directives for emission and immunity to interference (EN 61326-1 Industrial, EN/IEC 61326-2-1).

Safety complies to applicable safety regulation IEC/EN 61010-1.

This product complies with directive 2011/65/EU.

Single-channel (portable / benchtop)

Weight:

2.7 kg (6 lbs) to 4.4 kg (9.7 lbs) net without main adapter

Dimensions:

incl. rubber: 124 mm H x 182 mm W x 301 mm L [4.88 in H x 7.17 in W x 11.85 in L]
with RF output connector type N: 124 mm H x 182 mm W x 310 mm L [4.88 in H x 7.17 in W x 12.20 in L]

Multi-channel (rack-mountable) 19" 2HU enclosure

Weight:

18 kg (37 lbs) net, \leq 25 kg (55 lbs) shipping

Dimensions:

Body: 86 mm H x 444 mm W x 572mm L [3.39 in H x 17.5 in W x 22.5 in L]

Recommended calibration cycle: 24 months



Document History

Version/Status	Date	Author	Notes
V110	2019-10-28	jk	Update
V111	2020-02-20	yg/jk	Update
V113	2020-03-31	jk	Analog modulations revised, option EI/Q added, measurement plots added
V114	2020-04-31	jk	New plots added
V120	2020-11-10	jk	Extended to multi-channel, 12 GHz model
V121	2021-1-10	jk	Power specs refined, data plots added
V122	2021-05-03	rp	Pulse modulation, marker, multi-function in/outputs specs refined
V123	2021-06-01	ee	Updated product images
V124	2021-06-25	jk	Refined power ranges
V125	2021-07-20	rp	Updated FCP/baseband generator
V126	2022-02-04	jk	Plot update
V127	2022-03-21	jk/rp	Update
V128	2022-03-29	jk ee	Option PE2 for APVSG6/12, Option PE4, Option LN+, Reference bypass info Updated product images
V129	2022-10-29	jk	Phase Noise data refined
V130	2023-03-30	rp re	Update on sweep data, SD card, internal pulse generator Option PDW added
V131	2023-12-08	ap	Added harmonics plot for APVSG06

AnaPico of Switzerland

Europa-Strasse 9
8152 Glattbrugg
Switzerland

Phone +41 44 440 00 50
Email sales@anapico.com

www.anapico.com
www.anapico.com/downloads/

